

Pneumatic Accessories

Silencer - Exhaust Protector - Performance Exhaust Protector - Shuttle Valve

Series
346 - M - 888

Silencer (1) (2) (5) - Exhaust Protector (3) (4)

		(1)	(2)	(3)
Operating pressure		0 to 10 bar		0 to 12 bar
Ambient temperature range		-10°C to +80°C		
Construction	body	porous plastic	porous bronze	bronze
	connection piece	plastic	brass	brass
Catalog number				
Pipe size	Ø M5	34600405	34600207	34600491
	G 1/8	34600406	34600001	34600492
	G 1/4	34600407	34600002	34600493
	G 3/8	34600408	34600003	34600494
	G 1/2	34600409	34600004	34600495
	G 3/4	34600410	34600005	34600496
	G 1	34600411	34600006	34600497

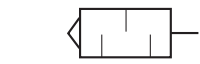

		(4)		(5)	
Operating pressure		0 to 14 bar		0 to 10 bar	
Ambient temperature range		-20°C to +110°C		-10°C to +80°C	
Construction	body	zinc-plated steel, bichromate		stainless steel	
	connection piece	brass		nickel plated brass	
	diffuser	-		-	
		G (ISO 228/1)	M	G (ISO 228/1)	NPT
Catalog number					
Pipe size	Ø M5	-	34600484	-	-
	1/8"	M1MB	-	34600418	34600482
	1/4"	M2MB	-	34600419	34600483
	3/8"	M3MB	-	34600478	-
	1/2"	M4MB	-	34600479	34600481
	3/4"	M5MB	-	-	-
	1"	M6MB	-	-	-

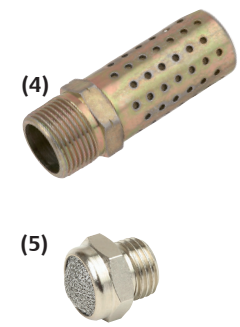

Performance Exhaust Protector (6)

		(6)			flow coefficient		
Operating pressure		0 to 16 bar ⁽¹⁾					
Ambient temperature range		-60°C to +90°C					
Construction	body	stainless steel AISI 316L					
	mesh	stainless steel AISI 316					
	seal	NBR					
		G (ISO 228/1)	E (ISO 7/1)	NPT	Cv	Kv	
		Catalog number				(m³/h)	(l/min)
Pipe size	1/4"	G888A11210A0000	E888A11210A0000	8888A11210A0000	3.0	2.6	43
	3/8"	G888A11310A0000	E888A11310A0000	8888A11310A0000	4.4	3.8	64
	1/2"	G888A11410A0000	E888A11410A0000	8888A11410A0000	7.8	6.8	113
	3/4"	G888A11510A0000	E888A11510A0000	8888A11510A0000	13.5	11.6	194
	1"	G888A11610A0000	E888A11610A0000	8888A11610A0000	28.2	24.4	407
	1" 1/2 ⁽¹⁾	G888A11710A0000	E888A11710A0000	8888A11710A0000	65.0	57.0	944
2" ⁽¹⁾	G888A11810A0000	E888A11810A0000	8888A11810A0000	138.0	119.0	1987	



⁽¹⁾ Version 1" 1/2 and 2" available on special request and max. 10 bar.

Shuttle Valve

Fluids Air or filtered neutral gas, lubricated or not

Operating pressure 1 to 10 bar

Ambient temperature range -10°C to +60°C

Construction

Body Black anodised aluminium

Internal parts Steel + NBR (nitrile)

pipe size	Ø orifice (mm)	Catalog number
G 1/8	3.2	34600127
G 1/4	6	34600119

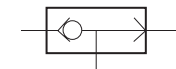

00221CB-2021/R01 Availability, design and specifications are subject to change without notice. All rights reserved.

Dimensions (mm), Weight (kg)

Silencer (1) (2) (5) - Exhaust Protector (3) (4) - Performance Exhaust Protector (6)

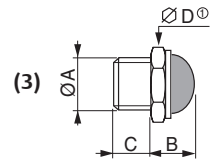
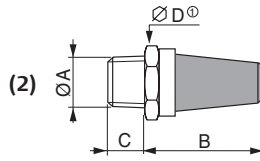
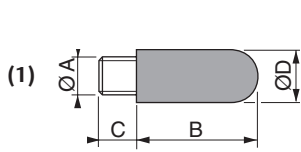

Catalog number	ØA	B	C	ØD	weight
34600405	M5	17.5	4	6.5	0.0005
34600406	G1/8	28.5	5.5	12.5	0.002
34600407	G1/4	34.5	8	15.5	0.004
34600408	G3/8	56	11.5	18.5	0.006
34600409	G1/2	66.5	11	23.3	0.010
34600410	G3/4	115.5	16	38.5	0.040
34600411	G1	140	21	49	0.065

Catalog number	ØA	B	C	ØD	weight
34600207	M5	18	4	8	0.004
34600001	G1/8*	22.4	5.6	13	0.010
34600002	G1/4*	41.6	8.4	16	0.030
34600003	G3/8*	49.2	8.8	24	0.030
34600004	G1/2*	54.6	11.4	27	0.070
34600005	G3/4*	82.3	12.7	36	0.300
34600006	G1*	93.5	14.5	50	0.400

Catalog number	ØA	B	C	ØD	weight
34600491	M5	8	3.5	8	0.002
34600492	G1/8	11	6	13	0.007
34600493	G1/4	12	8	16	0.011
34600494	G3/8	14	8	19	0.016
34600495	G1/2	16	10	24	0.027
34600496	G3/4	16	10	30	0.044
34600497	G1	18	11.5	36	0.065

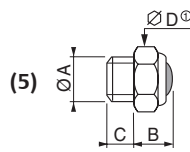
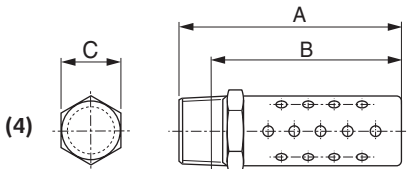

Catalog number	Ø	A	B	C	weight
M1MB	G1/8	35	31	11	0.009
M2MB	G1/4	44	39	14	0.023
M3MB	G3/8	57	51	18	0.036
M4MB	G1/2	69	61	22	0.068
M5MB	G3/4	80	71	27	0.036
M6MB	G1	99	88	33	0.227

Catalog number	ØA	B	C	ØD	weight
34600484	M5	4.5	3.2	8	0.001
34600418	G1/8	10	6	13	0.006
34600419	G1/4	11	8	16	0.010
34600478	G3/8	11	9	19	0.014
34600479	G1/2	14	9	24	0.023

① D: Across flats

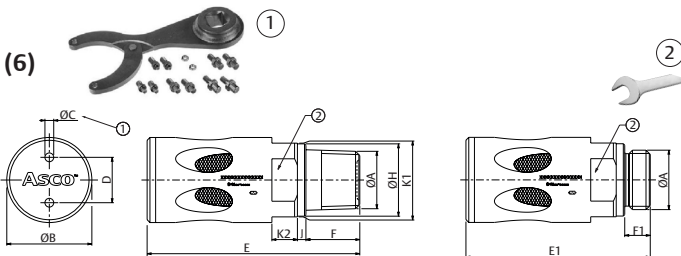

Catalog number	ØA	ØB	① ØC	① D	E (NPT) (ISO 7/1)	E1 (ISO 228/1)	F (NPT) (ISO 7/1)	F1 (ISO 228/1)	ØH	J	②		weight (kg)
											K1	K2	
x888A11210A0000	1/4"	18	2 x 2.6	8	61.5	43	15	6.5	18	2	14	6	0.07
x888A11310A0000	3/8"	25	2 x 2.6	14	60.5	53	15	7.5	21	2.5	21	8	0.14
x888A11410A0000	1/2"	30	2 x 3.1	16	75	65	19	9	25.5	3	26	9	0.22
x888A11510A0000	3/4"	45	2 x 4.1	24	95	86.5	19	10.5	32	3	38	14	0.67
x888A11610A0000	1"	55	2 x 6.1	32	118	106.5	23	11.5	38	3	46	14	1.20
x888A11710A0000	1 1/2"	80	2 x 8.1	48	151	143.5	25	17.5	55	3	70	20	3.2
x888A11810A0000	2"	110	2 x 10.1	70	195	189.5	25	19.5	67	3.5	100	28	8.0

① Pin hole spanner
② Open end spanner

Shuttle Valve

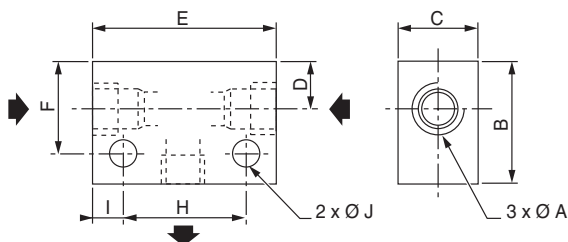

Catalog number	ØA	B	C	D	E	F	H	I	J	weight
34600127	G1/8	26	16	8.5	51	20.5	32	9.5	4.5	0.150
34600119	G1/4	30	20	10.5	52	21.5	35	8.5	5.5	0.210

Pneumatic Accessories

Non-Return Valve - Quick Exhaust Valve - Pneumatic Indicator

Series
346

Non-Return Valve

Fluids		Air or filtered neutral gas, lubricated or not
Operating pressure	plastic body	1 to 10 bar
	metal body	0.5 to 10 bar
Ambient temperature range		-10°C to +60°C
Construction		
Body	instant fittings version	Technical polymer
	tapped version	Brass nickeled
Internal parts		Light alloy and brass
Seals		NBR (nitrile)



pipe size	flow at 6 bar (l/min)	Catalog number
(1) Plastic body (instant fittings)		
Ø 4 mm (OD)	330	34602445
Ø 6 mm (OD)	665	34602446
Ø 8 mm (OD)	1630	34602447
(2) Metal body (tapped)		
Ø M5	190	34602412
G 1/8	920	34602124
G 1/4	1650	34602125
G 3/8	2400	34602444
G 1/2	3500	34602126



Quick Exhaust Valve

Fluid		Air or filtered neutral gas, lubricated or not
Operating pressure		0.5 to 10 bar
Ambient temperature range		-10°C to +60°C
Construction		
Body		Light alloy
Diaphragm		NBR (nitrile)

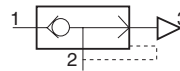

pipe size	Ø orifice (mm)	Catalog number
G 1/4	12	34600136
G 3/8	12	34600137
G 1/2	20	34600138
G 3/4	20	34600139



Pneumatic Indicator

Fluid		Air or filtered neutral gas, lubricated or not
Operating pressure		2 to 8 bar
Ambient temperature range		+50°C to +70°C
Angle of vision		180°
Construction		
Lens		PC (polycarbonate)
Body and collar		POM (polyacetal)
Nut		Brass



color	Catalog number
red	34600130
green	34600131
yellow	34600132



Dimensions (mm), Weight (kg) 

Non-Return Valve

(1) Plastic body (instant fittings)

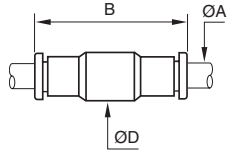

Catalog number	ØA (OD)	B	C	ØD	weight
34602445	4 mm	38	-	16	0.008
34602446	6 mm	41	-	16	0.013
34602447	8 mm	51.5	-	19	0.018

(2) Metal body (tapped)

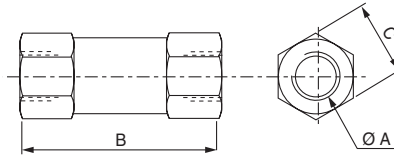

Catalog number	ØA	B	C	weight
34602412	Ø M5	25	8	0.008
34602124	G 1/8	36.5	13	0.025
34602125	G 1/4	41	-16	0.041
34602444	G 3/8	51	20	0.074
34602126	G 1/2	62	24	0.120

Quick Exhaust Valve

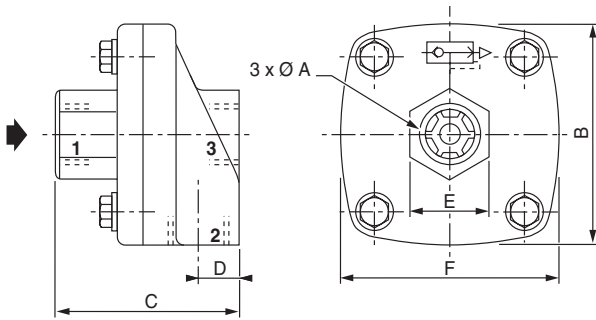

Catalog number	ØA	B	C	D	E	F	weight
34600136	G1/4	64	52	13	25	64	0.185
34600137	G3/8	64	52	13	25	64	0.185
34600138	G1/2	85	72	19	38	97	0.420
34600139	G3/4	85	72	19	38	97	0.390

Pneumatic Indicator

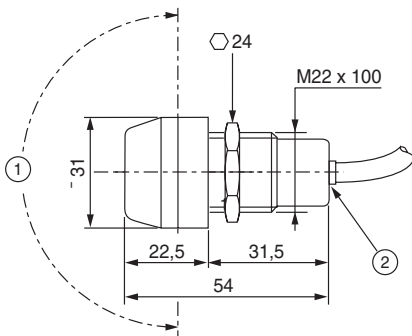

Catalog number	weight
34600130	0.035
34600131	
34600132	

- ① Angle of vision 180°
- ② Instant fittings for flexible tube Ø 4 mm OD