

ASCO™ MINIATURE SOLENOID VALVES

LEVER SOLENOID FLUID ISOLATION VALVES

- Lever mechanism isolation valves designed for use with aggressive and corrosive liquids and gases in analytical instrumentation and the chemical manufacturing industries
- Large orifice sizes make these valves ideal for high flow-rate and high pressure applications
- Ideally suited for quickly flushing systems of corrosive media and routing aggressive reagents to chemical reaction vessels and waste containers
- Available in both a 2-Way normally closed and normally open versions, as well as 3-Way normally closed, normally open and universal versions; each with multiple connection options
- Meets all relevant CE directives, and is RoHS compliant
- Typical applications include:
 - Raw-material Chemical Manufacturing
 - Pharmaceutical
 - Chip/Wafer Manufacturing
 - Waste Water Treatment

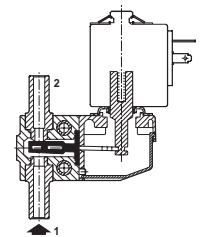
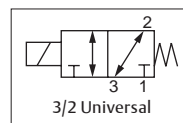
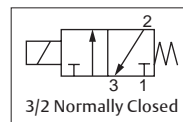
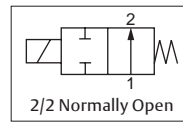
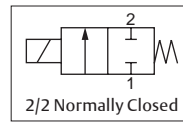

2/2 NC Function

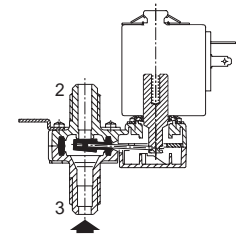

2/2 NC Function

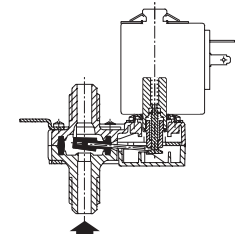

2/2 NO Function

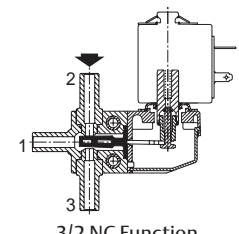

3/2 NC Function

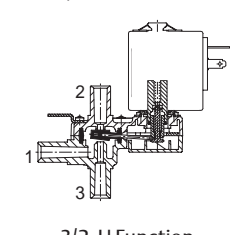

3/2 U Function

| Fluids* | Temperature Range | Seal Materials* |
|--|---------------------------------------|--|
| Air, Inert Gases, Filtered Water, Oil or Liquids | -10 °C to 100 °C (14 °F to 212 °F) | VMQ (silicone) FKM (fluoroelastomer) EPDM (ethylene-propylene) |

* Ensure that the compatibility of the materials in contact with the fluids is verified

| General Valve Information | | |
|---------------------------|-----------------------------|-------------------------------------|
| Body | PEI (polyetherimide) | G 1/2: PPS (polypropylene sulphide) |
| Response Time | ~ 25ms | |
| Max. Viscosity | 37 cSt (mm ² /s) | |

| Electrical Characteristics | |
|---------------------------------|--|
| Coil Insulation Class | F |
| Connector | Spade plug (cable Ø6-8mm or Ø6-10mm) |
| Connector Specification | with coil 6W/6W (BMX) DIN 43650, 11mm, industry standard B, with coil 8W/9W (AMX) ISO 4400/EN 175301-803, form A |
| Electrical Safety | IEC 335 |
| Electrical Enclosure Protection | Molded IP65 (EN 60529) |
| Standard Voltages ¹ | 12 VDC, 24 VDC AC ~: 24 V to 115 V to 230 V/50 Hz (BMX = 50 – 60 Hz) |

¹ Other voltages and 60 Hz available on request

| Prefix Option | Power Ratings | | | | Ambient Temperature Range | Replacement Coil | | Type ¹ |
|---------------|---------------|------------|------------|----|---------------------------|------------------|----------|-------------------|
| | Inrush VA | Holding VA | Hot/Cold W | | | 230 V/50 Hz | 24 VDC | |
| | | | W | W | | | | |
| SC | 16 | 10 | 6 | 6 | -10 to 60 (14 to 40) | 43005164 | 43005149 | 01 (BMX) |
| | 23 | 14 | 8 | 9 | -10 to 60 (14 to 40) | 43005149 | 43005144 | 02 (AMX) |
| | 44 | 24 | 8 | 13 | -10 to 60 (14 to 40) | 43005320 | 43005317 | 03 (FNX) |

¹ Refer to the dimensional drawings on the following page

01021GB-2019-R01

| Specifications | | | | | | | | | | | | |
|---|-----------------|--------------|------------------|------|------------------------------|----------------------|-------------|------------------|----|----------------|---------|------|
| Spigot O.D. | Pipe connection | Orifice Size | Flow coefficient | | Operating Pressure bar (psi) | | | Power Rating (W) | | Catalog number | Options | |
| | | | | | min. | max. | | | | | | |
| mm (inches) | | mm (inches) | Kv (m³/h) | Cv | | inert gases | liquids | ~ | = | | FKM | EPDM |
| 2/2 NC - Normally closed, VMQ Seals | | | | | | | | | | | | |
| 8 (0.31) | - | 2.7 (0.11) | 0.23 | 0.27 | 0 | 5 (72.5) [10/145] | 5 (72.5) | 6 | 6 | SCH283A003 | V | E |
| 8 (0.31) | - | 3.4 (0.13) | 0.30 | 0.35 | 0 | 3 (43.5) [6/87] | 3 (43.5) | 6 | 6 | SCH283A004 | V | E |
| 11 (0.43) | - | 5.5 (0.22) | 0.55 | 0.64 | 0 | 1.5 (21.8) | 1 (14.5) | 8 | 9 | SCH283A010 | - | - |
| - | G 1/4 | 3.2 (0.13) | 0.32 | 0.37 | 0 | 1.5 (21.8) | 1.5 (21.8) | 8 | 9 | SCG283A013 | - | - |
| - | G 1/4 | 5.5 (0.22) | 0.55 | 0.64 | 0 | 1.5 (21.8) | 1 (14.5) | 8 | 9 | SCG283A014 | - | - |
| 2/2 NC - Normally closed, EPDM Seals | | | | | | | | | | | | |
| 11 (0.43) | - | 5.5 (0.22) | 0.55 | 0.64 | 0 | 4.5 (65.3) | 1 (14.5) | 8 | 9 | SCH283A008E | V | - |
| - | G 1/4 | 3.2 (0.13) | 0.32 | 0.37 | 0 | 10 (145) | 2.4 (34.81) | 8 | 9 | SCG283A011E | V | - |
| - | G 1/4 | 5.5 (0.22) | 0.55 | 0.64 | 0 | 4.5 (65.3) | 1 (14.5) | 8 | 9 | SCG283A012E | V | - |
| - | G 1/2 | 10 (0.394) | 1.6 | 1.85 | 0 | 1.6 (23.2) | 0.25 (3.63) | 13 | 13 | SCG283C006E | V | - |
| 2/2 NO - Normally open, VMQ Seals | | | | | | | | | | | | |
| 8 (0.31) | - | 3.4 (0.13) | 0.30 | 0.35 | 0 | 3 (43.5) [6/87] | 3 (43.5) | 6 | 6 | SCH283A016 | V | E |
| 2/2 NO - Normally open, FKM Seals | | | | | | | | | | | | |
| 11 (0.43) | - | 5.5 (0.22) | 0.55 | 0.64 | 0 | 1.5 (21.8) | 1 (14.5) | 8 | 9 | SCH283A018V | - | - |
| 3/2 NC - Normally closed, VMQ Seals | | | | | | | | | | | | |
| 8 (0.31) | - | 3.4 (0.13) | 0.30 | 0.35 | 0 | 1 (14.5) | 1 (14.5) | 6 | 6 | SCH383A003 | V | E |
| 3/2 NO - Normally open, FKM Seals | | | | | | | | | | | | |
| 8 (0.31) | - | 3.4 (0.13) | 0.30 | 0.35 | 0 | 2.5 (36.2) | 2 (29) | 6 | 6 | SCH383A004V | - | - |
| - | G 1/2 | 9 (0.35) | 1.6 | 1.85 | 0 | 0.4 (5.8) | - | 13 | -* | SCG383C006 | - | - |
| 3/2 NO - Normally open, EPDM Seals | | | | | | | | | | | | |
| 8 (0.31) | - | 3.4 (0.13) | 0.30 | 0.35 | 0 | 2.5 (36.2) | 2 (29) | 6 | 6 | SCH383A004E | - | - |
| 3/2 U - Universal, VMQ Seals | | | | | | | | | | | | |
| 11 (0.43) | - | 3.2 (0.12) | 0.28 | 0.32 | 0 | 1.5 (21.8) | 1.5 (21.8) | 8 | 9 | SCH383A007 | V | E |
| - | G 1/4 | 3.2 (0.12) | 0.28 | 0.32 | 0 | 1.5 (21.8) | 1.5 (21.8) | 8 | 9 | SCG383A008 | V | E |

* AC Version available only
[] Value for pressure with FKM and EPDM seals

How to Order

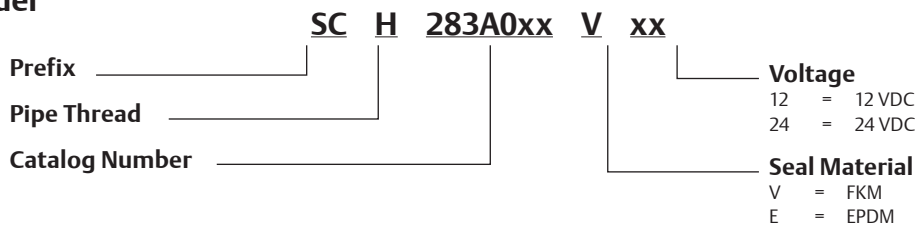

ASCO™ MINIATURE SOLENOID VALVES

LEVER SOLENOID FLUID ISOLATION VALVE

SERIES
283/383

Dimensions: mm (inches)



TYPE 01
Prefix "SC" Solenoid
DIN 43650



TYPE 02
Prefix "SC" Solenoid
ISO 4400

SCH283A003/A004/A016

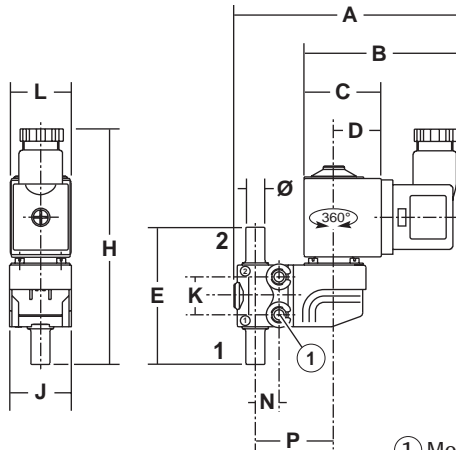

① Mounting: 2 holes
4.3mm (0.17in)

SCH283A010/A008/A018V

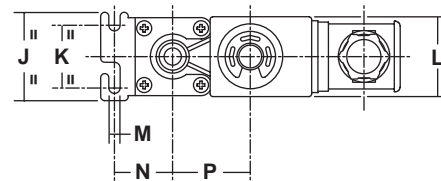
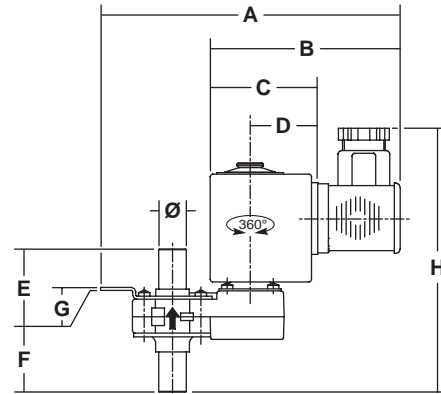

Pressure inlet:

NC function: orifice 1 (type 01) or arrow on body (type 02)

NO function: orifice 2 (type 01) or arrow on body (type 02)

| Type | Prefix Option | Catalog Number | A | B | C | D | E | F | G | H | J | K | L | M | N | P | Weight ² kg |
|------|---------------|-----------------------|--------|--------|--------|--------|--------|--------|---------|--------|--------|--------|--------|--------|--------|--------|------------------------|
| 01 | SC | SCH283A003/A004 | 94 | 64.5 | 33.5 | 21 | 58 | - | - | 97 | 26 | 16 | 25 | - | 10 | 33 | 0.170 |
| | | SCH283A016 | (3.7) | (2.54) | (1.32) | (0.83) | (2.28) | - | - | (3.82) | (1.02) | (0.63) | (0.98) | - | (0.39) | (1.30) | 0.200 |
| 02 | SC | SCH283A010/A008E/018V | 121.5 | 78 | 43 | 27 | 16.5 | 40.5 | 1.2 | 105 | 35 | 25 | 32 | 4.5 | 23 | 31 | 0.285 |
| | | | (4.78) | (3.07) | (1.69) | (1.06) | (0.65) | (1.59) | (0.047) | (4.13) | (1.38) | (0.98) | (1.26) | (0.18) | (0.91) | (1.22) | |

² Including coil(s) and connector(s)

01021GB-2019-R01

Dimensions: mm (inches)



TYPE 01
Prefix "SC" Solenoid
ISO 4400



TYPE 02
Prefix "SC" Solenoid
ISO 4400

**SCG283A011/012/
013/014/019V**

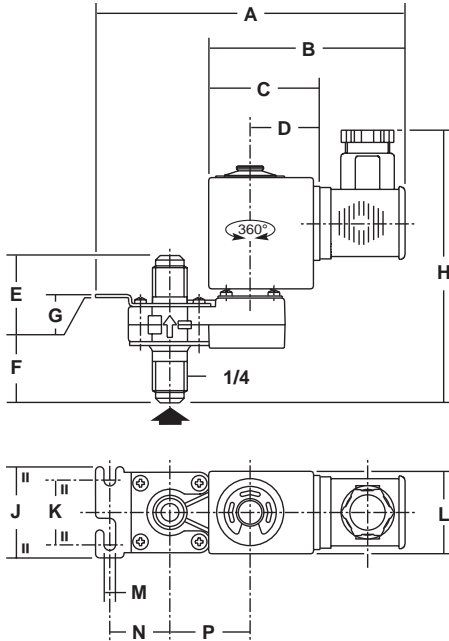

SCG283C006

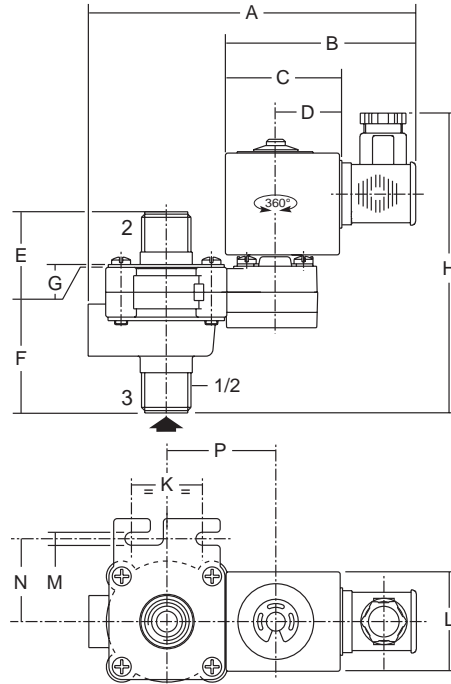

Pressure inlet:

NC function: arrow on body (type 01) or orifice 3 (type 02)
NO function: arrow on body (type 01)

| Type | Prefix Option | Catalog Number | A | B | C | D | E | F | G | H | J | K | L | M | N | P | Weight ² kg |
|------|---------------|-----------------------------------|-----------------|--------------|--------------|--------------|----------------|----------------|----------------|---------------|--------------|--------------|--------------|----------------|---------------|--------------|------------------------|
| 01 | SC | SCG283A011E/ 012E/013/014/019V | 121.5 (4.78) | 78 (3.07) | 43 (1.69) | 27 (1.06) | 16.5 (0.65) | 40.5 (1.59) | 1.2 (0.047) | 105 (4.13) | 35 (1.38) | 25 (0.98) | 32 (1.26) | 4.5 (0.177) | 23 (0.906) | 31 (1.22) | 0.285 |
| 02 | SC | SCG283C006E | 142.5 (5.61) | 84 (3.31) | 49 (1.93) | 28 (1.10) | 23.5 (0.93) | 61.5 (2.42) | 1.2 (0.047) | 128 (5.04) | - | 30 (1.18) | 42 (1.65) | 5.5 (0.217) | 35 (1.38) | 46 (1.81) | 0.57 |

² Including coil(s) and connector(s).

ASCO™ MINIATURE SOLENOID VALVES

LEVER SOLENOID FLUID ISOLATION VALVE

SERIES
283/383

Dimensions: mm (inches)



TYPE 01
Prefix "SC" Solenoid
DIN 43650



TYPE 02
Prefix "SC" Solenoid
ISO 4400

SCH383A003 / A004V / A004E

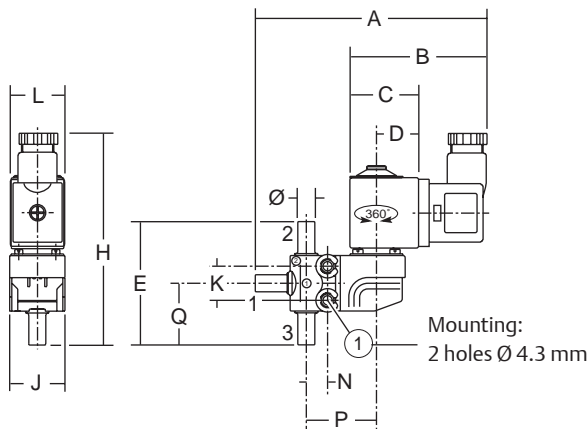

SCH383A007

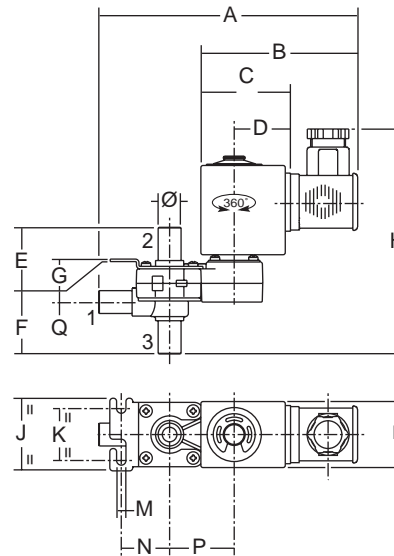

Pressure inlet:

NC function: orifice 2 (type 01)
NO function: orifice 3 (type 01)
U function: all orifices (type 02)

| Type | Prefix Option | Catalogue number | A | B | C | D | E | F | G | H | J | K | L | M | N | P | Q | Weight ² kg |
|------|---------------|------------------------|---------------|----------------|----------------|--------------|----------------|----------------|---------------|---------------|--------------|--------------|--------------|---------------|--------------|--------------|----------------|------------------------|
| 01 | SC | SCH383A003/A004V/A004E | 111 (4.37) | 64.5 (2.54) | 33.5 (1.32) | 21 (0.83) | 58 (2.28) | - | - | 97 (3.82) | 26 (1.02) | 16 (0.63) | 25 (0.98) | - | 10 (0.39) | 33 (1.30) | 29 (1.14) | 0.200 |
| 02 | SC | SCH383A007 | 127 (5.0) | 78 (3.07) | 43 (1.69) | 27 (1.06) | 16.5 (0.65) | 40.5 (1.59) | 1.2 (0.05) | 105 (4.13) | 35 (1.38) | 25 (0.98) | 32 (1.26) | 4.5 (0.18) | 23 (0.91) | 31 (1.22) | 19.5 (0.77) | 0.345 |

² Including coil(s) and connector(s).

01021GB-2019-R01

Dimensions: mm (inches)



TYPE 01
Prefix "SC" Solenoid
ISO 4400

SCG383A008



TYPE 02
Prefix "SC" Solenoid
ISO 4400

SCG383C006

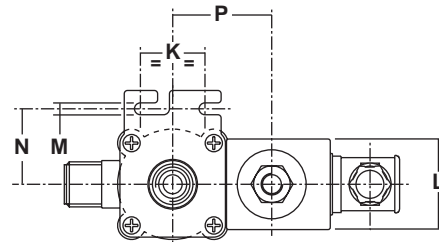
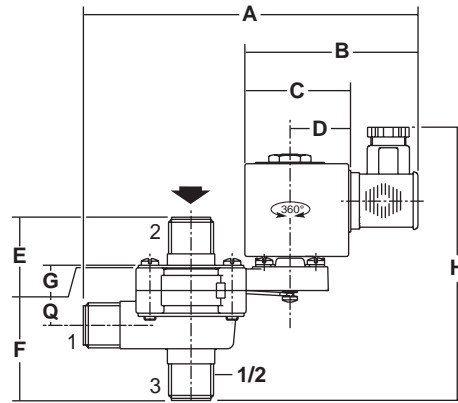
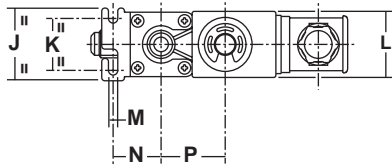
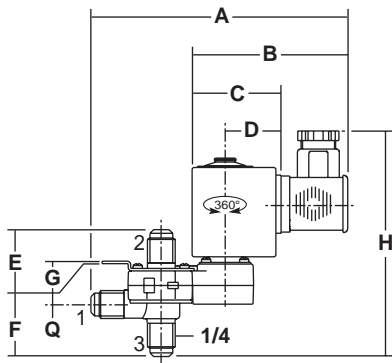

| Type | Prefix option | Catalogue number | A | B | C | D | E | F | G | H | J | K | L | M | N | P | Q | Weight ² kg |
|------|---------------|------------------|---------------|--------------|--------------|--------------|----------------|----------------|---------------|---------------|--------------|--------------|--------------|---------------|--------------|--------------|----------------|------------------------|
| 01 | SC | SCG383A008 | 127 (5.0) | 78 (3.07) | 43 (1.69) | 27 (1.06) | 16.5 (0.65) | 44.5 (1.75) | 1.2 (0.05) | 109 (4.29) | 35 (1.38) | 25 (0.98) | 32 (1.26) | 4.5 (0.18) | 23 (0.91) | 31 (1.22) | 19.5 (0.77) | 0.345 |
| 02 | SC | SCG383C006 | 159 (6.26) | 84 (3.31) | 49 (1.93) | 28 (1.10) | 23.5 (0.93) | 61.5 (2.42) | 1.2 (0.05) | 128 (5.04) | - | 30 (1.18) | 42 (1.65) | 5.5 (0.22) | 35 (1.38) | 46 (1.81) | 26.5 (1.04) | 0.51 |

² Including coil(s) and connector(s).

Options

- Valves can also be supplied with FKM (fluoroelastomer) and EPDM (ethylene-propylene) seals.
- Plug with visual indication and peak voltage suppression or with cable length of 2m (78.7in)

Installation

- The solenoid valves can be mounted in any position without affecting operation. For optimum performance mount solenoid vertical and upright
- Replacement coils are available: BMX: DC: 12 V, cat. no.: 43005158 / AC: 24 V, cat. no.: 43005161; 115 V, cat. no.: 43005162
AMX: DC: 12 V, cat. no.: 43005143/AC: 24 V, cat. no.: 43005146