

ASCO™ Solenoid Valves

single/dual solenoid (mono/bistable function) - pilot operated
brass body - "NAMUR" style - 1/4" tapped

3/2 NC - 5/2
SERIES
551

Features

- The monostable spool valves in conformity with IEC 61508 Standard (2010 route 2_h version) have TÜV certified with integrity levels: SIL 2 for HFT = 0 / SIL 3 for HFT = 1
- The solenoid operated spool valves have threaded port connections and "NAMUR" interface
- The same spool valve can be adapted for 3/2 NC or 5/2 functions for controlling double-acting and single-acting actuators
- All the exhaust ports of the spool valve are connectable, providing better environmental protection. Particularly recommended for sensitive areas, such as clean rooms, and applications in the pharmaceutical and food processing sectors
- The valves offer environmental protection against the ingress of liquids, dusts or other foreign matter (environmentally-protected construction)
- Can be externally piloted (external air pilot supply) to convert valve to zero minimum operation by flipping a gasket
- The solenoid valves satisfy all relevant EU Directives

General

Differential pressure 2 - 10,4 bar [1 bar = 100 kPa]
Flow (Qv at 6 bar) 700 l/min (ANR)

fluids (*)	temperature range (TS)	seal materials (*)
air, inert gas, filtered	-40°C to +60°C	VMQ (silicone) + PUR (polyurethane)

Materials in contact with fluid

(*) Ensure that the compatibility of the fluids in contact with the materials is verified

Body, end covers	Brass
Spool valve internal parts	Brass, stainless steel, POM
Interface plates	Glass fibre filled PA
Core tube	Stainless steel
Core and plugnut	Stainless steel
Core spring	Stainless steel
Seals & discs	NBR
Top disc	PA
Disc holder	POM
Cartridge (low power)	Welded, packless AISI 430
Seat	Brass
Seat insert	POM
Shading coil	Copper
Rider rings (low power)	PTFE (NF/WSNF solenoids only)

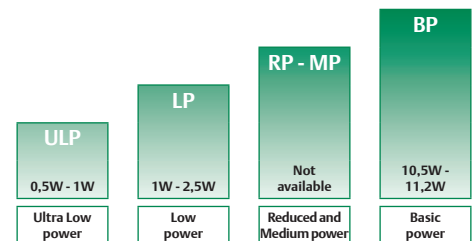
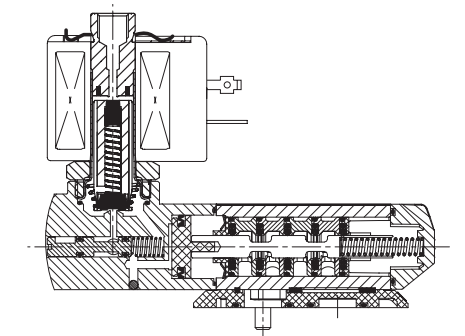
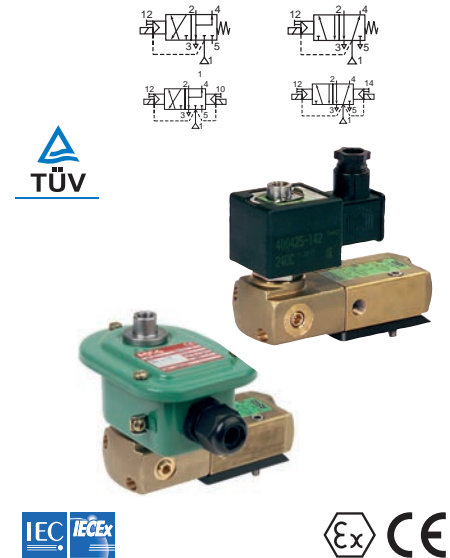

POWER LEVELS - cold electrical holding values (watt)

Specifications

pipe size	orifice size	flow coefficient Kv		operating pressure differential (bar)			power level	prefix optional solenoids							basic catalogue number			
								min. ⁽¹⁾	max PS		NEMA 7 & 9	NEMA 7 & 9 ATEX IECEx	ATEX / IECEx				IP65	
									air (*)	~			=	EF ⁽²⁾		EV ⁽²⁾		Ex db
(*)	(mm)	(m ³ /h)	(l/min)				~/=	LPKF	NF	EM	PV	(WS)	LI	SC				
3/2 NC - 5/2 - Solenoid air pilot operated - spring return (monostable)																		
1/4	6	0,60	10	0 / 2	10	10	BP	-	-	-	●	●	●	-	●	❖551A403 ⁽³⁾		
							BP	●	●	-	-	-	-	-	-	❖551H403 ⁽³⁾		
							LP	-	-	●	●	●	○	-	●	❖551A303 ⁽³⁾		
							LP	○	○	-	-	-	-	-	-	❖551G303 ⁽³⁾		
							ULP	-	-	○	-	-	-	○	-	❖551A303 ⁽³⁾		
ULP	○	○	-	-	-	-	-	-	-	❖551H303 ⁽³⁾								
3/2 NC - 5/2 - Solenoid air pilot operated and return (bistable)																		
1/4	6	0,60	10	0 / 2	10	10	BP	-	-	-	●	●	●	-	●	❖551A404		
							BP	●	●	-	-	-	-	-	-	❖551H404		
							LP	-	-	●	●	●	○	-	●	❖551A304		
							LP	○	○	-	-	-	-	-	-	❖551G304		
							ULP	-	-	○	-	-	-	○	-	❖551A304		
ULP	○	○	-	-	-	-	-	-	-	❖551H304								

❖ Select 8 for NPT ANSI 1.20.3 or select G for ISO G (228/1) ● Available feature ○ Available feature in DC only. - Not available

⁽¹⁾ Zero minimum is only achieved if external pressure is applied.

⁽²⁾ UL CSA

⁽³⁾ Certified IEC 61508 Functional Safety data, use suffix "SL".

Prefix table

prefix							description	power level			
1	2	3	4	5	6	7		ULP	LP	MP	BP
E	F						Explosionproof - NEMA 7, 9 - Zinc plated steel conduit (18" continuous leads)	○	○	-	●
E	F	H	T				EF (18" continuous leads) + high temperature	○	○	-	●
E	F	H	T	L			EF + high temperature + 72" continuous leads	○	○	-	●
E	F	L					EF + 72" continuous leads	○	○	-	●
J	B	E	F				EF + Junction box (conduit in 1/2" NPT)	○	○	-	●
J	B	E	F	M	F		EF + Junction box (conduit in 1/2" NPT) + surge suppression coils	○	○	-	●
J	C	E	F				EF + Junction box (conduit in 3/4" NPT)	○	○	-	●
J	C	E	F	H	T		EF + Junction box (conduit in 3/4" NPT) + high temperature	○	○	-	●
E	V						Explosionproof - NEMA 7, 9 - 316 SS conduit (18" continuous leads)	○	○	-	●
E	V	H	T				EV (18" continuous leads) + high temperature	○	○	-	●
E	V	H	T	L			EV + high temperature + 72" continuous leads	○	○	-	●
E	V	L					EV + 72" continuous leads	○	○	-	●
E	V	M	F				EV + surge suppression coils	○	○	-	●
E	V	M	F	L			EV + surge suppression coils + 72" continuous leads	○	○	-	●
E	M						Waterproof IP66/67 - Metal enclosure (EN/IEC 60079-7,-18 and -31)*	-	●	-	●
		E	T				Threaded conduit/hole (M20 x 1,5)	-	●	-	●
L	P	K	F				Flameproof - Aluminium (EN/IEC 60079-1, 60079-31)*	○	●	-	-
N	F						Flameproof - Aluminium (EN/IEC 60079-1, 60079-31)*	-	○	-	●
P	V						Encapsulated epoxy moulded (EN/IEC 60079-18)*	-	○	-	●
S	C						Solenoid with spade plug connector (EN/IEC 60730)	-	●	-	●
W	P						Waterproof IP67 - Metal enclosure	-	●	-	●
L	I						I.S. with Aluminium IP66/IP67 enclosure (EN/IEC 60079-11+31)*	○	-	-	-
W	S						Waterproof IP67 - 316 SS enclosure	-	●	-	●
W	S	L	P	K	F		Flameproof 316L SS (EN/IEC 60079-1, 60079-31)*	○	○	-	-
W	S	E	M				Waterproof IP66/67 - 316 SS enclosure (EN/IEC 60079-0+7+18+31)*	-	●	-	●
W	S			L	I		I.S. with 316L SS IP66/IP67 enclosure (EN/IEC 60079-11+31)*	○	-	-	-
W	S	N	F				Flameproof 316L SS (EN/IEC 60079-1, 60079-31)*	-	●	-	●
					H	T	Threaded conduit (1/2" NPT)	-	●	-	●
						X	Class H - High temperature, +80°C ambient temp.	-	●	-	●
							Other special constructions	-	●	-	●

Product selection guide

STEP 1

Select basic catalogue number, including pipe thread identification letter. Refer to the specifications table on page: 1

Example: G551A403

STEP 2

Select prefix (combination). Refer to the specifications table and the prefix table, respect the indicated power level.

Example: EM

STEP 3

Select suffix (combination) if required. Refer to the suffix table, respect the indicated power level.

Example: MO

STEP 4

Select voltage. Refer to standard voltages on page: 3

Example: 230V / 50Hz

STEP 5

Final catalogue / ordering number.

Example:

EM G551A403MO 230 V / 50 Hz

Suffix table

suffix							description	power level			
1	2	3	4	5	6	7		ULP	LP	MP	BP
			M	O			Push type manual operator	○	○/●	-	●
	S	L					Certified IEC 61508 Functional Safety data (1)	○	○/●	-	●

Options & Accessories

series	pipe size	exhaust protector (stainless steel)
551	G 1/8	34600418 (2)
	NPT 1/8	34600482 (2)
	M5	34600484 (2)

● Available feature

○ Available feature in DC only

- Not available

* ATEX/IECEx valves using these solenoids are approved according to EN ISO 80079-36 (2016) and EN ISO 80079-37 (2016) [non electrical]

(1) Not to use with MO suffix

(2) Provided with "SL" suffix

Ordering examples valves:

SC	G	551	A	403		230V / 50 Hz
SC	G	551	A	403	SL	230V / 50 Hz
SC	G	551	A	404	MO	230V / 50 Hz
SCHT	8	551	A	404	MO	230V / 50 Hz
WSLPGF	G	551	A	303	MO	24V / DC
LPKF	G	551	A	303	MO	24V / DC
LPKF	G	551	A	303	MO	230V / 50 Hz
LI	G	551	A	307		24V / DC
WSLI	G	551	A	308	MO	24V / DC
LPKF	G	551	A	303	MO	24V / DC
EM	8	551	A	403	MO	230V / 50 Hz
EF	G	551	H	403	MO	240V / 60 Hz

prefix — pipe thread — basic number — voltage — suffix

Explanation of temperature ranges of solenoid valves

Valve temperature range	The valve temperature range (TS) is determined by the selected seal material, the temperature range for proper operation of the valve and sometimes by the fluid (e.g. steam)
Operator ambient temperature range	The operator ambient temperature range is determined by the selected power level and the safety code
Total temperature range	The temperature range of the complete solenoid valve is determined by the limitations of both temperature ranges above

Electrical characteristics

Coil insulation class	F
Electrical safety	IEC 335
Standard voltages	DC (=) 24V - 48V AC (-) 24V - 48V - 115V - 230V ⁽¹⁾ /50Hz; other voltages and 60Hz are available on request

prefix option	power ratings				operator ambient temperature range (TS) (C°) ⁽²⁾	safety code	electrical enclosure protection (EN 60529)	replacement coil / kit		type ⁽³⁾
	inrush ~	holding ~	hot/cold =	~				=		
	(VA)	(VA) (W)	(W)						230 V/50 Hz	
Basic power (BP)										
SC	55	23	10,5	9/11,2	-40 to +75	EN 60730	IP65, moulded	400425-117	400425-142	01
WP/WS	55	23	10,5	9/11,2	-40 to +75	EN 60730	IP67, steel /SS	400405-117	400405-142	03
NF/WSNF	55	23	10,5	-	-60 to +25/40/60	II2G Ex db IIC Gb T6/T5/T4, II2D Ex tb IIIC Db	IP66/67, alu./SS	400405-117	-	02
NF/WSNF	-	-	-	9/11,2	-60 to +40/60/75	II2G Ex db IIC Gb T6/T5/T4, II2D Ex tb IIIC Db	IP66/67, alu./SS	-	400405-142	02
EM/WSEM	55	23	10,5	9/11,2	-40 to +40	II2G Ex eb mb IIC Gb T3, II2D Ex tb IIIC Db	IP66/67, steel /SS	400909-117	400913-142	03
PV	55	23	10,5	9/11,2	-40 to +65	II2G Ex mb IIC Gb T3(-)/T4(=), II2D Ex mb IIIC Db	IP67, moulded	- ⁽⁴⁾	- ⁽⁴⁾	04
EF	55	23	10,5	9/11,2	-40 to +52/40	NEMA type 7 and 9	NEMA 4X	-	-	05
EFHT	55	23	10,5	9/11,2	-40 to +52/40	NEMA type 7 and 9	NEMA 4X	-	-	05
JBEF	55	23	10,5	9/11,2	-40 to +52/40	NEMA type 7 and 9	NEMA 4X	-	-	11
JBEFHT	55	23	10,5	9/11,2	-40 to +52/40	NEMA type 7 and 9	NEMA 4X	-	-	11
EV	55	23	11,6	9/11,6	-40 to +52/40	ATEX II2G Ex db mb IICT* Gb II2D Ex mb tb IIIC T* Db IECEX Ex db mb IICT* Gb Ex mb tb IIIC T* Db	NEMA 4X	-	-	05
EVHT	55	23	11,6	9/11,6	-40 to +52/40	ATEX II2G Ex db mb IICT* Gb II2D Ex mb tb IIIC T* Db IECEX Ex db mb IICT* Gb Ex mb tb IIIC T* Db	NEMA 4X	-	-	05
EVMF	55	23	11,6	9/11,6	-40 to +52/40	ATEX II2G Ex db mb IICT* Gb II2D Ex mb tb IIIC T* Db IECEX Ex db mb IICT* Gb Ex mb tb IIIC T* Db	NEMA 4X	-	-	05
Low Power (LP)										
SC	1,5	1,5	1,5	1,7/1,7	-40 to +60	EN 60730	IP65, moulded	400925-097	400925-042	06
WP/WS	1,5	1,5	1,5	1,7/1,7	-40 to +60	EN 60730	IP67, steel /SS	400926-097	400926-042	08
LPKF/WSLPKF	2,4	2,4	2,4	-	-40 to +40/65/80	II2G Ex db IIB+H2 Gb T6/T5/T4, II2D Ex tb IIIC Db	IP66/67, alu./SS	- ⁽⁴⁾	- ⁽⁴⁾	12
LPKF/WSLPKF	-	-	-	2,1 ⁽⁵⁾	-40 to +40/80	II2G Ex db IIB+H2 Gb T6/T4, II2D Ex tb IIIC Db	IP66/67, alu./SS	- ⁽⁴⁾	- ⁽⁴⁾	12
NF/WSNF	1,85	1,85	1,85	1,5/1,8	-60 to +75/80	II2G Ex db IIC Gb T6/T5, II2D Ex tb IIIC Db	IP66/67, alu./SS	- ⁽⁴⁾ (1)	- ⁽⁴⁾	07
EM/WSEM	1,5	1,5	1,5	1,7/1,7	-40 to +40/55	II2G Ex eb mb IIC Gb T6/T5, II2D Ex tb IIIC Db	IP66/67, steel /SS	- ⁽⁴⁾	- ⁽⁴⁾	08
PV	-	-	-	1,7/1,7	-40 to +65	II2G Ex mb IIC Gb T6, II2D Ex mb IIIC Db	IP67, moulded	-	- ⁽⁴⁾	09
EF	-	-	-	1,8/1,8	-40 to +60	NEMA type 7 and 9	NEMA 4X	-	-	10
EFHT	-	-	-	1,8/1,8	-40 to +60	NEMA type 7 and 9	NEMA 4X	-	-	10
JBEF	-	-	-	1,8/1,8	-40 to +60	NEMA type 7 and 9	NEMA 4X	-	-	11
JBEFHT	-	-	-	1,8/1,8	-40 to +60	NEMA type 7 and 9	NEMA 4X	-	-	11
EV	-	-	-	1,7/1,7	-40 to +60	ATEX II2G Ex db mb IICT* Gb II2D Ex mb tb IIIC T* Db IECEX Ex db mb IICT* Gb Ex mb tb IIIC T* Db	NEMA 4X	-	-	10
EVHT	-	-	-	1,7/1,7	-40 to +60	ATEX II2G Ex db mb IICT* Gb II2D Ex mb tb IIIC T* Db IECEX Ex db mb IICT* Gb Ex mb tb IIIC T* Db	NEMA 4X	-	-	10
EVMF	-	-	-	1,7/1,7	-40 to +60	ATEX II2G Ex db mb IICT* Gb II2D Ex mb tb IIIC T* Db IECEX Ex db mb IICT* Gb Ex mb tb IIIC T* Db	NEMA 4X	-	-	10

80112CB-2019/R02

3/2 NC - 5/2 SERIES 551

prefix option	power ratings			operator ambient temperature range (TS) (C°) ⁽²⁾	safety code	electrical enclosure protection (EN 60529)	replacement coil / kit		type ⁽³⁾
	inrush	holding	hot/cold				~	=	
	(VA)	(VA) (W)	(W)				230 V/50 Hz	24V/DC	
Ultra Low Power (ULP)									
LPKF/WSLPKF	-	-	0,5/0,5 ⁽⁵⁾	-40 to +60	II2G Ex db IIB+H2 Gb T6, II2D Ex tb IIIC Db	IP66/67, alu./SS	-	- ⁽⁴⁾	12
EF	-	-	0,55/0,7	-40 to +52/40	NEMA type 7 and 9	NEMA 4X	-	-	10
EFHT	-	-	0,55/0,7	-40 to +52/40	NEMA type 7 and 9	NEMA 4X	-	-	10
JBEF	-	-	0,55/0,7	-40 to +52/40	NEMA type 7 and 9	NEMA 4X	-	-	10
JBEFHT	-	-	0,55/0,7	-40 to +52/40	NEMA type 7 and 9	NEMA 4X	-	-	11
EV	-	-	0,55/0,7	-40 to +52/40	NEMA type 7 and 9, ATEX II 2G Ex db mb IICT* Gb II 2D Ex mb tb IICT* Db IECEX Ex db mb IICT* Gb Ex mb tb IICT* Db	NEMA 4X	-	-	10
EVHT	-	-	0,55/0,7	-40 to +52/40	NEMA type 7 and 9, ATEX II 2G Ex db mb IICT* Gb II 2D Ex mb tb IICT* Db IECEX Ex db mb IICT* Gb Ex mb tb IICT* Db	NEMA 4X	-	-	10
EVMF	-	-	0,55/0,7	-40 to +52/40	NEMA type 7 and 9, ATEX II 2G Ex db mb IICT* Gb II 2D Ex mb tb IICT* Db IECEX Ex db mb IICT* Gb Ex mb tb IICT* Db	NEMA 4X	-	-	10
LI ⁽⁶⁾⁽⁷⁾	-	-	0,5/0,5	-40 to +60	II1G Ex ia IIC T6 Ga, II2D Ex tb IIIC Db ⁽⁷⁾	IP66/67, alu.	-	- ⁽⁴⁾	13
WSLI ⁽⁶⁾⁽⁷⁾	-	-	0,5/0,5	-40 to +60	II1G Ex ia IIC T6 Ga, II2D Ex tb IIIC Db ⁽⁷⁾	IP66/67, SS	-	- ⁽⁴⁾	13

prefix option	safety parameters				
	U _i (DC)	I _i	P _i	L _i	C _i
	(V)	(mA)	(W)	(H)	(µF)
Ultra Low Power (ULP)					
LI/WSLI	32	500	1,5	0	0

⁽¹⁾ (WS)NF: Low Power, 230 V AC does not exist. Maximum voltage in AC is 115 V

⁽²⁾ Temperature range can be limited by sealings

⁽³⁾ Refer to the dimensional drawings on pages: 5 to 8

⁽⁴⁾ Multiple coil kits are available under ATEX/IECEX, contact us

⁽⁵⁾ LPKF/WSLPKF: 24 V DC (0,5 W)

⁽⁶⁾ LI/WSLI: Check the electrical characteristics in the corresponding catalogue pages

⁽⁷⁾ LI/WSLI: Ultra Low Power, 24 V DC only (LI: **For use in zone 0 locations, see the installation conditions given in the I&M instructions**)

- Not available

Electrical connections

prefix	connection
SC	Spade plug connector with cable gland EN175301-803A (ISO 4400) for cables with an outer diameter from 6 to 10 mm
WP, WS, EM, WSEM	M20 plastics cable gland for cables with an outer diameter from 7 to 12 mm.
NF, WSNF, LPKF, WSLPKF	1/2" NPT threaded cable entry. Enclosures are supplied without cable gland
PV	Moulded-in cable, standard length 2 m
LI, WSLI	1/2" NPT threaded cable entry. Enclosures are supplied without cable gland
EF, EV	1/2" NPT conduits
JBEF	EF + Junction box

Additional options

- Valves configured for external pilot air supply, TPL 20547
- Other pipe threads are available on request
- Ex mb (prefix "PV") solenoid can be supplied with various cable lengths
- Set of stainless steel mounting screws (series 551), catalogue number: **97802212**
- Set of two G 1/8 exhaust reducers (series 551), catalogue number: **88100344**

Installation

- Multi language installation/maintenance instructions are included with each valve
- The solenoid valves can be mounted in any position without affecting operation
- 3/2 NC-5/2 spool valve supplied with one interface plate with NAMUR mating surface. Depending on function (3/2 NC or 5/2), position the plate on the spool valve body before installing on actuator
- Do not connect the pressure supply to the exhaust port 3. The "environmentally-protected" construction is not adapted for NO function. Contact us for function available in specific version
- Dowel pin (if necessary), bolts and gaskets are standard supplied
- IEC 61508 Functional Safety (suffix SL). Check temperature range of valve body and solenoid for suitability. For probability of failure, contact us
- It is necessary to connect pipes or fittings to the exhaust ports to protect the internal parts of the spool valve and its pneumatic operator if used outside or in harsh environments (dusts, liquids etc.)
- Threaded pipe connection identifier is 8 = NPT (ANSI 1.20.3); G = G (ISO 228/1)
- Ex db Prefix "NF/WSNF" enclosure is provided with a 1/2" NPT threaded entry hole, M20 x 1,5 (prefix "ET") is optional. These are supplied without cable gland
- To comply with IEC 61508 (SIL) the valves must be provided with a specific exhaust protector (see following pages)

Dimensions (mm), Weight (kg)



All types

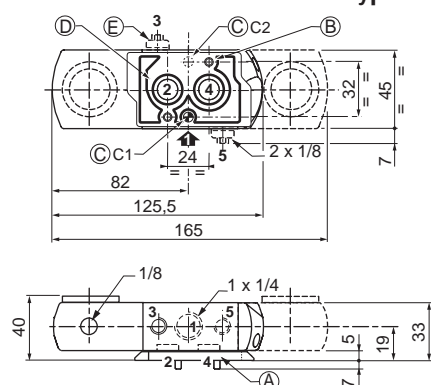

- (A) Interface plate
- (B) 2 mounting holes: 5,3 mm dia. (Spotfacing: 9 mm dia., depth 5 mm); 2 screws (CHc M5 x 35), engaged length: 7 mm
- (C) One 5 mm dia. hole for dowel pin:
 - in position C1: 3/2 NC function plate
 - in position C2: 5/2 function plate
- (D) 2 O-ring seals (supplied)



TYPE 01:
Epoxy moulded
SC: IEC 335 / ISO 4400

551A403 / 551A404



TYPE 02:
Aluminium, epoxy coated / AISI 316L SS
NF / WSNF: EN/IEC 60079-1, 60079-31

551A403 / 551A404

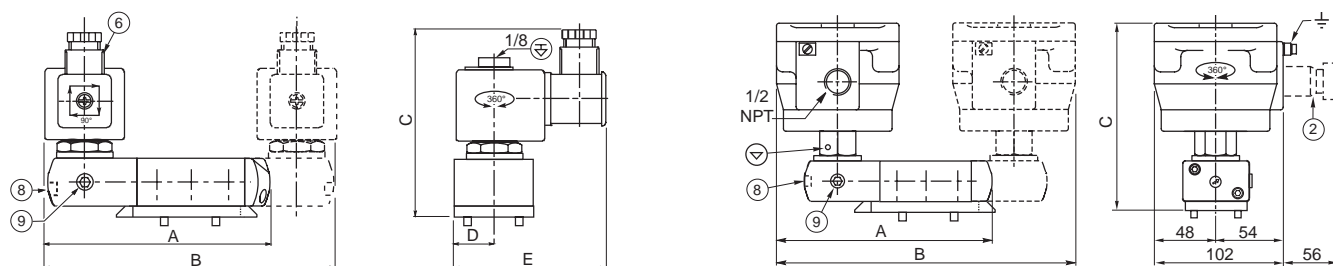

**3/2 NC - 5/2
SERIES
551**

Dimensions (mm), Weight (kg)



TYPE 03:
Metal, epoxy coated / AISI 316L SS
WP / WS: IEC 335
EM / WSEM: EN/IEC 60079-7+18+31

551A403 / 551A404

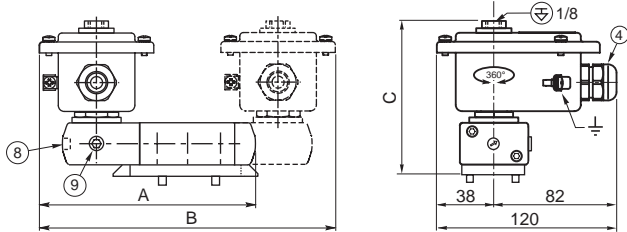

TYPE 04:
Epoxy encapsulated
PV: EN/IEC 6007

551A403 / 551A404

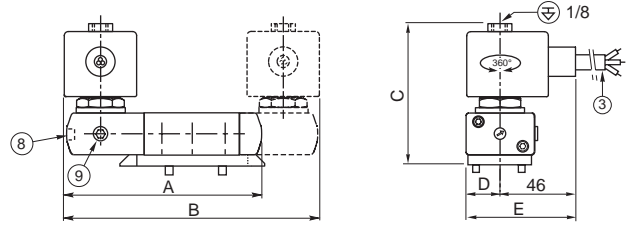

TYPE 05:
Epoxy encapsulated
EF and EV: NEMA type 7, 9 / ICS-6 ANSI

551H403 / 551H404

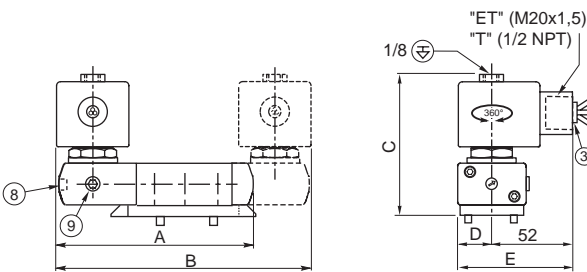

TYPE 06:
Epoxy moulded
SC: IEC 335 / ISO 4400

551A303 / 551A304

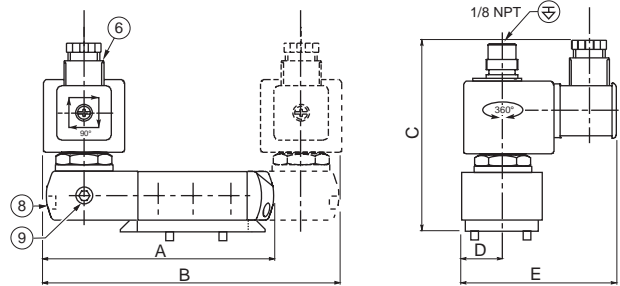

TYPE 07:
Aluminium, epoxy coated / AISI 316L SS
NF / WSNF: EN/IEC 60079-1, 60079-31

551A303 / 551A304

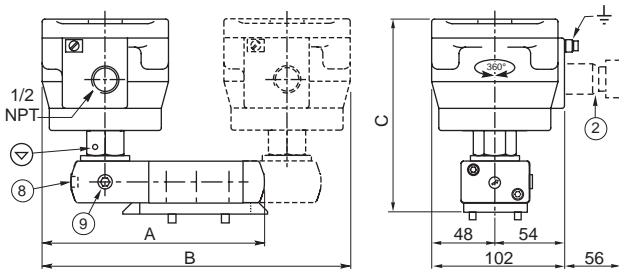

TYPE 08:
Metal, epoxy coated / AISI 316L SS
WP / WS: IEC 335
EM / WSEM: EN/IEC 60079-7+18+31

551A303 / 551A304

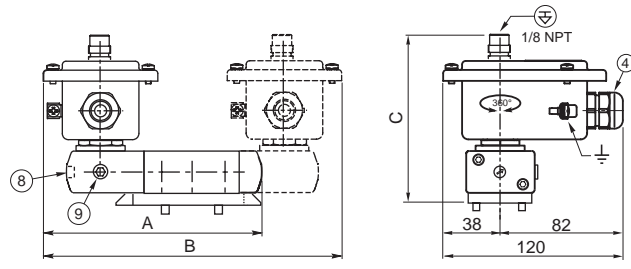

80112GB-2019/R02

Dimensions (mm), Weight (kg)



TYPE 09:
Epoxy encapsulated
PV: EN/IEC 60079-18

551A303 / 551A304



TYPE 10:
Epoxy encapsulated
EF and EV: NEMA type 7, 9 / ICS-6 ANSI

551G303 / 551H303 / 551G304 / 551H304

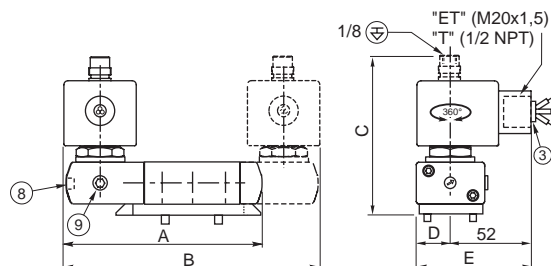
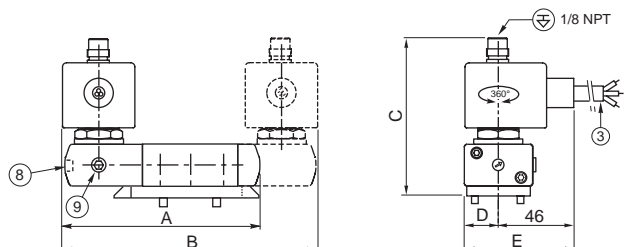

TYPE 11:
Epoxy encapsulated
JBEF: NEMA type 7, 9

551G303 / 551H303 / 551G304 / 551H304



TYPE 12:
Aluminium, cataphoresis black painting / AISI 316L SS
LPKF/WSLPKF: EN/IEC 60079-1, 60079-31

551A303 / 551A304

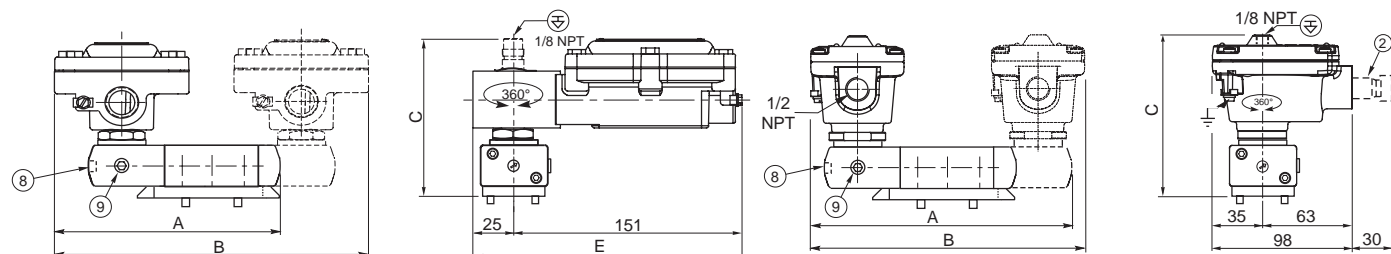

TYPE 13:
Aluminium, cataphoresis black painting / AISI 316L SS
LI / WSLI: EN/IEC 60079-11, 60079-31

551A303 / 551A304

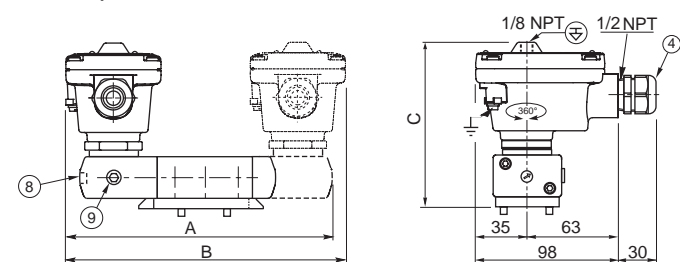

3/2 NC - 5/2 SERIES 551

Dimensions (mm), Weight (kg)

type	prefix/option	power level	A	B	C	D	E	weight ⁽¹⁾	
								monostable	bistable
01	SC	BP	144	182	107,7	22,5	86,5	1,45	1,96
02	NF	BP	170	236	146,8	-	-	2,49	4,25
02	WSNF	BP	170	236	146,8	-	-	3,79	5,55
03	WP/WS/EM/WSEM	BP	160	216	108	-	-	1,62	2,23
04	PV	BP	144	184	93	22,5	67,5	1,46	2,19
05	EF / EV	BP	144,5	185	90,5	22,5	74,5	1,47	2,20
06	SC	LP	144,5	185	106,5	22,5	87,5	1,45	2,41
07	NF	LP	170	236	146,8	-	-	2,49	4,25
07	WSNF	LP	170	236	146,8	-	-	3,79	5,55
08	WP / WS / EM / WSEM	LP	160	216	107,2	-	-	1,69	2,23
09	PV	LP	144	184	105,5	22,5	67,5	1,67	2,40
10	EF / EV	LP / ULP	144,5	185	105,5	22,5	74,5	1,66	2,39
11	JBEF	BP / LP / ULP	146,5	207	105,5	-	176	2,17	3,21
12	LPKF	LP / ULP	135	186	118	-	-	1,00	1,65
12	WSLPKF	LP / ULP	135	186	118	-	-	1,61	2,85
13	LI	ULP	135	186	118	-	-	1,01	1,66
13	WSLI	ULP	135	186	118	-	-	1,62	2,86

⁽¹⁾ Incl. coil(s) and connector(s).

- ② Ex d certified cable gland (on request)
- ③ Three-core cable, length 2 m
- ④ Cable gland for unarmoured cable with 7 to 12 mm dia. sheath
- ⑥ Connector rotatable by 90° increments (cable Ø 6 - 10 mm)
- ⑧ Manual operator location, suffix MO
- ⑨ External pilot air supply, 1/8 pipe size
- ⊖ Connectable pilot exhaust port
- ⊕ Non-connectable pilot exhaust port

Accessories

