

EXPLOSIONPROOF EQUIPMENT

Product Index

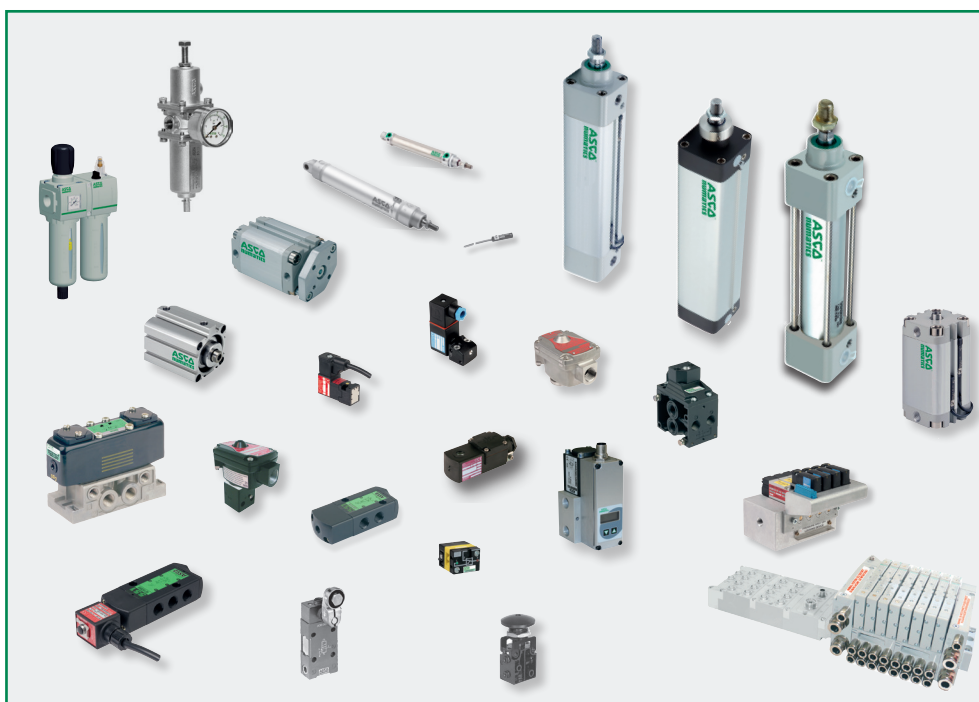

		Description					Page
		Hazardous areas Identification					IV-V VI
		Equipment groups and temperature classes / Certificates - Products Standards (CENELEC - CEN standards)					VII-VIII 1-3 4.6
Standard	Description	zone	Pipe connections	illustration	Series	Page	
Pneumatic cylinders							
SHORT STROKE CYLINDERS							
	II 2 GD c - Ta 40°C T 85°C (T6) - Ta 70°C T 100°C (T5) II 3 GD c - Ta 40°C T 85°C (T6) - Ta 70°C T 100°C (T5)	1-21 2-22			441	Cylinders & Actuators	
ISO 21287	<i>Compact cylinders</i> II 2 GD c - Ta 40°C T 85°C (T6) - Ta 70°C T 100°C (T5) II 3 GD c - Ta 40°C T 85°C (T6) - Ta 70°C T 100°C (T5)	1-21 2-22			449		
ROUND ISO CYLINDERS							
ISO 6432	II 2 GD c - Ta 40°C T 135°C (T4) - Ta 70°C T 200°C (T3)	1-21			435	Cylinders & Actuators	
ISO 6431	II 3 GD c - Ta 40°C T 135°C (T4) - Ta 70°C T 200°C (T3)	2-22			438		
ISO 15552 CYLINDERS							
ISO 15552	With profiled barrel	II 2 GD c IIC Ta 70°C T 135°C (T4) II 3 GD c IIC Ta 70°C T 135°C (T4)	1-21 2-22			453	Cylinders & Actuators
		<i>Food industry applications</i> II 2 GD c IIC Ta 70°C T 135°C (T4) II 3 GD c IIC Ta 70°C T 135°C (T4)	1-21 2-22			454	
	With tie-rods	II 2 GD c IIC Ta 70°C T 135°C (T4)	1-21			450	
		II 3 GD c IIC Ta 70°C T 135°C (T4)	2-22				
Magnetic sensors							
ATEX	"T" model, reed switch or magneto-resistive type		0-20 2-22		494 (reed)	7 9 11 (mounting kits)	
	II 1GEx ia IIC T4 Ga / II 1D Ex ia IIIC T135°C Da II 3G Ex nA T4 X / II 3D Ex tD A22 IP67 T125°C X				494 (MR)		

00449GB-2017/R01
Availability, design and specifications are subject to change without notice. All rights reserved.

All leaflets are available on: www.asco.com



青岛秉诚自动化设备有限公司
地址：中国·青岛市重庆南路99号海尔云街甲3号楼7F

服务热线：4006-918-365
网址：<http://www.asco.store>

Explosionproof equipment - I
传真：(86-532)585-10-365
Email：sales@bechinas.com

Function	Description	Zones	Pipe connections	illustration	Series	Page
Proportional valves						
3/2	SENTRONIC ^{PLUS} II 2D Ex tb IIIC T135 °C Db II 3G Ex nA IIC T4 Gc, 0 ≤ Ta ≤ +50 °C	1-22	1/8 1/4 1/2 1		614	Proportional Valves digital electronics with external pneumatic pressure supply
Air operated valves						
3/2 NC 5/2 NAMUR	spool valves aluminium body II 2GD IIC T85°C (T6) X	1-21	1/4 1/2		551	Air Operated 3/2 - 5/2
	stainless steel body II 1 GD c (551)/ II 2 GD c (553)	2-22			553	3/2 - 5/2 NAMUR
4/2	poppet valves II 2 GD c - Ta 40°C T 85°C (T6) / II 3 GD c - Ta 40°C T 85°C (T6)	1-21 2-22	instant fittings G1/8-G1/4		263 264	Air Operated
5/2-5/3	spool valves, ISO1-ISO2-ISO3 II 2 GD c - Ta 60°C T 85°C (T6) / II 3 GD c - Ta 60°C T 85°C (T6)	1-21	pad mount G1/8 to G3/4		541	Air Operated
		2-22			542 543	
Solenoid air operated valves						
4/2	poppet valves II 2 GD c - Ta 40°C T 85°C (T6) II 3 GD c - Ta 40°C T 85°C (T6)	1-21	instant fittings G1/8 G1/4		263 264	Pneumatic Valves
		2-22				
5/2-5/3	spool valves (ISO1-ISO2-ISO3) II 2 GD c - Ta 60°C T 85°C (T6) II 3 GD c - Ta 60°C T 85°C (T6)	1-21	pad mount G1/8 to G3/4		541 542 543	
		2-22				
3/2 NC 5/2 5/3 NAMUR	Solenoid air operated spool valves, pilot operated (aluminium, brass or stainless steel body) LPKF/WSLPKF operators: II2G Ex d IIB+H2 T6, II2D Ex tD A21 IP67 T85°C LI/WSLI operators: II1G Ex ia IIC T6 Ga, II2D Ex t IIIC IP67 T85°C Db	1-21	1/4-1/2		551-553	aluminium: 3/2-5/2-5/3-NAMUR brass: 3/2-5/2-NAMUR stainless steel: 3/2-5/2-5/3-NAMUR
		0-21			551	
3/2 NC	Solenoid valves, direct operated, aluminium body, with LPKF type operator II2G Ex d IIB+H2 Gb T6..T4, II2D Ex t IIIC Db IP67	1-21	ISO 15218 (CNOMO, size 30)		314/ LPKF	www.asco.com
3/2 NC 5/2 5/3 NAMUR	Solenoid air operated spool valves, pilot operated (aluminium, brass or stainless steel body) (Pilot valve, 302 series: II 3G/3D Ex nA) (Pilot valves, Ex ia: 302,195/LISC, Piezotronic)	2-22	1/4-1/2		551-553	aluminium: 3/2-5/2-NAMUR stainless steel: 3/2-5/2-NAMUR
		1-21			551-553	
Solenoid pilot valves, coils and solenoid operators						
2/2 NC-NO 3/2 NC-NO-U	Solenoid valves, direct operated, plastic body, pad mount, ISO 15218 (CNOMO, size 15) II 3G Ex nA IIC T6..T4 Gc, II 3D Ex tc IIIC IP65 T85°C..T135°C Dc	2-22			302	www.asco.com
3/2 NC-NO	Solenoid valves, direct operated, plastic body, pad mount, ISO 15218 (CNOMO, size 15) II 1G Ex ia IIC T6, II 1D Ex ia IIIC T 85°C	0-20			630	www.asco.com
3/2 NC	Solenoid valves, direct operated, plastic body, pad mount, ISO 15218 (CNOMO, size 15) II 1 G Ex ia IIC T6..T4 Ga, II 1 D Ex ia IIIC T85°C .. T135°C IP65 Da					
3/2 NC	Solenoid valves, direct operated, aluminium body, pad mount, ISO 15218 (CNOMO, size 30) II 1G Ex ia IIC T6 Ga, II 2D Ex ib IIIC T85°C Db IP67				302	www.asco.com
2/2-3/2 5/2-5/3	Operators, moulded coil (EM5-MXX) II 2 G Ex mb II T6..T3, II 2 D Ex mD 21 IP67	1-21			195/ LISC	www.asco.com
					PV	
3/2 5/2-5/3	Operator, increased safety/encapsulated II 2G Ex e mb IIC T4 Gb, II 2D Ex t IIIC T135°C Db IP67 (22 and 30 sizes)	1-21			WBLP	www.asco.com
2/2-3/2 5/2-5/3	for dust applications II 3 D Ex tc IIIC T115°C Dc IP65X	22			SG	www.asco.com

 All leaflets are available on: www.asco.com
II - Explosionproof equipment

 青岛秉诚自动化设备有限公司
 地址：中国·青岛市重庆南路99号海尔云街甲3号楼7F

 服务热线：4006-918-365
 网址：<http://www.asco.store>

 传真：(86-532)585-10-365
 Email：sales@bechinas.com

Function	Description	Zones	Pipe connections	illustration	Series	Page
Manually and mechanically operated pneumatic valves						
3/2 NC-NO 5/2-5/3	Standard products not requiring ATEX 94/9/EC approval for use in potentially explosive atmospheres	1-21	1/8-1/4-3/8		307	Manually & Mechanically Operated Valves
3/2 NC-NO 5/2					308	
					309	
					310	
					320	
					550	
					551	
					552	
Spool valve islands						
	spool valve island Protocols: DeviceNet™, EtherNet/IP™, Modbus/TCP, Profibus DP, PROFINET, EtherNet/IP™ DLR, CHARM, IO-Link Class A (4 pin), IO-Link Class B (5 pin) Gas and Dusts: II 3G Ex nA IIC T4 Gc IP54 X or IP65 X II 3D Ex tc IIIA or IIIB T85°C Dc IP54 X or Ex tc IIIC T85°C Dc IP65 X Dusts: II 3G Ex nA IIC T4 Gc IP54 X	2-22	G 1/8		501	www.asco.com
					502	www.asco.com
	spool valve island II 2 GD	1-21	G 1/8 G 1/4		622	www.asco.com
Air Preparation, 651-652 Series						
	FR + L air preparation manifold assemblies Particulate Filter / Coalescing filter & absorber Regulator / Coalescing filter & absorber Particulate Filter / Manifold regulator Particulate filter/regulator /Coalescing filter/regulator Lubricator / Shut-off isolation valve Slow-start/quick exhaust valve / Diverter block II 2 GD IIC T85°C (T6) X / II 2 GD IIC T00°C (T5) X	1-21 2-22	1/8 to 1/2		651 652	Air Preparation
Air preparation, stainless steel AISI 316L, 342 Series						
	Filter, Regulator and Filter/Regulator (ATEX / CUTR / NACE) II 2GD IIC T100°C (T5), with 90°C ambient temperature II 2GD IIC T85°C (T6), with 75°C ambient temperature	1-21	1/4 - 1/2			www.asco.com
Pneumatic logic components						
	Sequencer registers, logics, threshold relays, timer relays, one-pulse generator, subbases II 2 GD c IIB 65°C T6X / II 2 GD c IIB 60°C T6X / II 2 GD c IIB T6X	1-21				Pneumatic Automation
Accessories						
	Pneumatic accessories	1-21 2-22			346	Coils & Accessories
	Cable glands Ex d, ATEX / IECEx, II 2 G Ex d IIC, II 2 D Ex tb IIIC	1-21			882	www.asco.com

00449GB-2017/R01
Availability, design and specifications are subject to change without notice. All rights reserved.

All leaflets are available on: www.asco.com

SOME HISTORY

The classification of hazardous areas into zones established the level of protection required for electrical equipment installed in explosive gas and dust atmospheres.

The two following standards define the areas:

IEC-EN 60079-10-1: Classification of areas, explosive gas atmospheres

IEC-EN 60079-10-2: Classification of areas, combustible dust atmospheres

The selection and construction of electrical installations is defined by standard IEC-EN 60079-14.

DEFINITION OF A PLACE WHERE A POTENTIALLY EXPLOSIVE ATMOSPHERE MAY OCCUR

The classification of an installation into distinct zones has two objectives (according to ATEX 1999/92/EC):

- To define the categories of equipment used in the zones indicated, provided they are suitable for gases, vapours or mists and/or dusts.
- To classify hazardous places into zones to prevent ignition sources and be able to select the correct electrical and non-electrical equipment accordingly. The zones are defined on the basis of the occurrence of explosive gaseous or dusty atmospheres.

GAS GROUPS

Group II : Equipment intended for use in places with an explosive gas atmosphere other than mines susceptible to firedamp.

Group I : Equipment intended for use in mines susceptible to firedamp.

	Zone	Category (ATEX 2014/34/EU)	Presence of explosive atmospheres
Group II	zone 0	1 G ⁽¹⁾	Continuous, frequent or for long periods
	zone 1	2 G	Intermittent in normal operation (likely)
	zone 2	3 G	Occasional or for short periods (never in normal operation)
Group I (mines)		M1 ⁽¹⁾	Presence (methane, dust)
		M2	Risk of presence (methane, dust)

DUST GROUPS (IEC 60079-0)

Group III : Equipment intended for use in places with an explosive dust atmosphere other than mines susceptible to firedamp.

	Zone	Category (ATEX 2014/34/EU)	Presence of explosive atmospheres
Group III	zone 20	1 D ⁽¹⁾	Continuous, frequent or for long periods (air/cloud of combustible dust)
	zone 21	2 D	Intermittent in normal operation
	zone 22	3 D	Occasional or for short periods

The classification of the installation is **the responsibility of the user**. He must individually evaluate each installation to determine the differences between them.

Separate assessments must be made for places with potentially explosive atmospheres caused by gases or vapours and for those caused by dusts.

EQUIPMENT PROTECTION LEVELS - EPLs

In normal circumstances the effect of the EPLs will be to retain the normal zone/equipment protection relationship. If, however, the risk is considered especially severe, then the required EPL for the zone may be increased. Similarly, if the risk is deemed to be especially small or negligible, the EPL may be reduced from the norm.

The following table shows the normal relationship between EPL and zone/category (without supplementary risk assessment).

Equipment Protection Level (EPL)	Normal Applicable Zone(s)	Category (2014/34/EU)
Ga	0 (and 1 and 2)	1G
Gb	1 (and 2)	2G
Gc	2	3G
Da	20 (and 21 and 22)	1D
Db	21 (and 22)	2D
Dc	22	3D
Ma / Mb	mines	M1 / M2

⁽¹⁾ G = gas ; D = dust ; M = mines

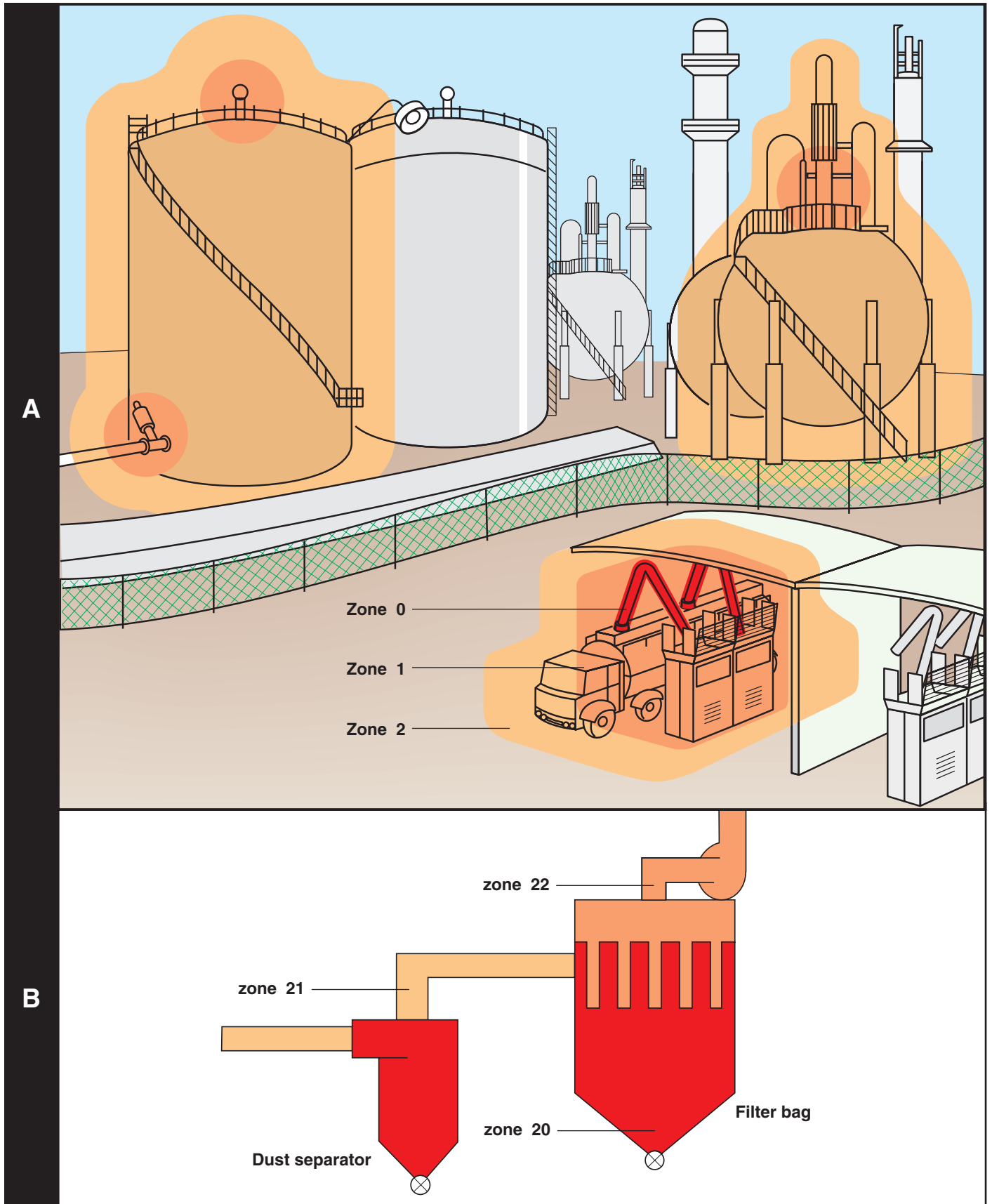

EXAMPLES OF A CLASSIFICATION INTO ZONES

Drawing **A** of an explosive atmosphere caused by gas:

Drawing **B** of an explosive atmosphere caused by dust:



Above drawings **A** and **B** are an example only and must not be used as a model for an actual plant whose design is, in every case, the responsibility of the constructor and operator.

00129GB-2017/R01
Availability, design and specifications are subject to change without notice. All rights reserved.

All leaflets are available on: www.asco.com

HOW CAN ATEX, EN-IEC 60079-0 OR EN 13463-1 APPROVED APPARATUS FOR USE IN EXPLOSIVE ATMOSPHERES BE IDENTIFIED?

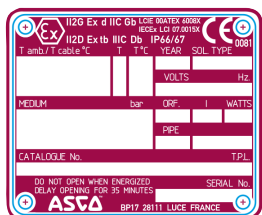
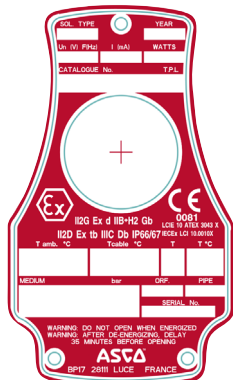
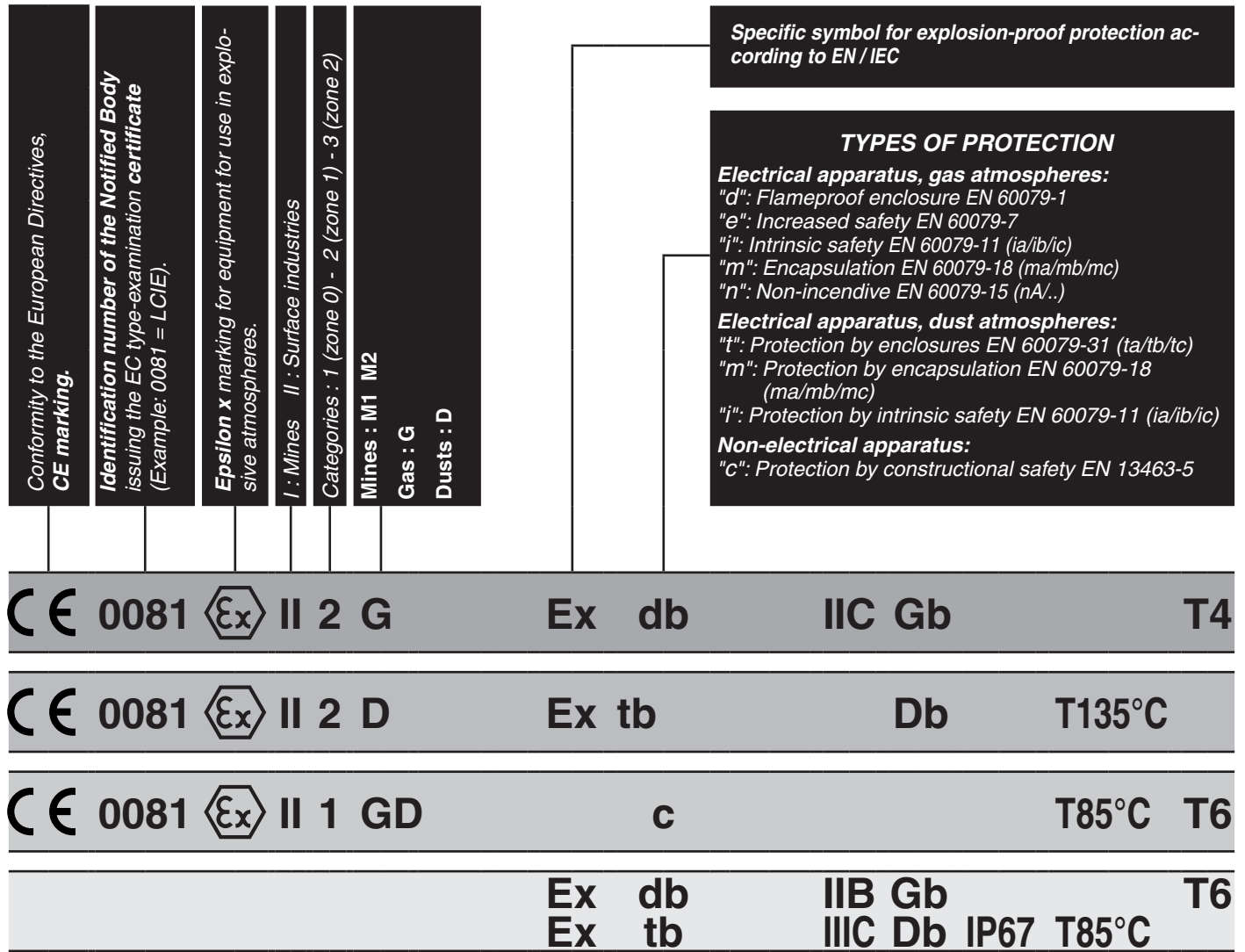

ma or ia = for use in zone 0 gas (D = Dusts)
mb or ib = for use in zone 1 gas (D = Dusts)

Equipment groups (IIA, IIB, IIC, IIIA, IIIB, IIIC)

Maximum surface temperature

Temperature class

Enclosure ingress protection (IP) rating for dust (EN 60529)

Equipment Protection Level (EPL)

CLASSIFICATION OF GASES INTO EXPLOSION GROUPS

Group I : Electrical equipment intended for use in the underground parts of mines, and to those parts of surface installations of such mines, likely to become endangered by firedamp and/or combustible dust.

Group II : Electrical equipment intended for use in other places likely to become endangered by explosive atmospheres (surface industries).

For the types of protection "d" and "i", group II is subdivided into **IIA, IIB, IIC**. Electrical apparatus certified for **IIB** may be used in applications requiring apparatus to be certified for group **IIA**. Electrical apparatus certified for **IIC** may be used in applications requiring apparatus to be certified for groups **IIA** and **IIB**.

For example the "d" and "i" types of protection are respectively subdivided according to the Maximum Experimental Safe Gap (MESG) and to the Minimum Igniting Current (MIC).

Electrical apparatus certified for **IIB** may be certified for use with a gas belonging to group **IIC**. In this case, the identification is supplemented with the chemical symbol or the name of the gas (example: Ex d IIB + H₂ according to EN 60079-0 and EN 60079.1).

The table below indicates the groups to which some gas mixtures belong:

Groups	Gas	Ignition temperature ⁽¹⁾ (°C)	Temperature class						
			T1	T2	T3	T4	T5	T6	
I	methane (firedamp)								
II	acetone	540	•						
	acetic acide	485	•						
	ammonia	630	•						
	ethane	515	•						
	methylene chloride	556	•						
	methane (CH ₄)	537	•						
	carbon monoxyde	605	•						
	propane	470	•						
	n-butane	365		•					
	n-butyl	370		•					
	n-hexane	240			•				
	acetaldehyde	140				•			
	ethyl ether	160				•			
	ethyl nitrite	90							•
	B	ethylene	425		•				
ethyl oxyde		429-440		•					
hydrogen sulfide		270			•				
C	acetylene (C ₂ H ₂)	305		•					
	carbon disulphide (CS ₂)	102							•
	hydrogen (H ₂)	560	•						

⁽¹⁾ Temperature of a hot surface able to ignite a gas mixture.

The ignition temperature of the gas mixture must be higher than the maximum surface temperature. In practice, a 10 to 20% safety margin is observed between the ignition temperature and the rated nameplate temperature.

The ignition temperature of a cloud of dust is generally between 300 and 700°C. At 150 to 350°C, the ignition temperature of a layer of dust is far below that of a dust cloud. A burning dust layer can initiate a dust explosion if brought in contact with a combustible dust cloud, so these values must be taken into account to limit the risk.

TEMPERATURE CLASS

The temperature classification is based on the maximum surface temperature of equipment. That is the highest temperature any part of or the entire surface of an electrical device can reach under the most unfavourable operating conditions capable of igniting a surrounding explosive atmosphere.

Group I : Temperature ≤ 150°C or ≤ 450°C according to coal dust accumulation on equipment

Group II : Equipment must be classified and marked:

- preferably with the temperature class (T classification)
- defined by the surface temperature or,
- limited to the specified flammable gases or dusts for which it is approved, if necessary (and marked accordingly).

Temperature class	Maximum surface temperature (°C)	Ignition temperature ⁽¹⁾ (°C)
T1	450	> 450
T2	300	> 300
T3	200	> 200
T4	135	> 135
T5	100	> 100
T6	85	> 85

CLASSIFICATION OF DUSTS INTO EXPLOSION GROUPS (IEC 60079-0)

Group III : Electrical equipment intended for use in places with an explosive dust atmosphere other than mines susceptible to firedamp.

Group III is subdivided into IIIA (combustible flyings), IIIB (non-conductive dust) and IIIC (conductive dust).

Combustible dust: Finely divided solid particles, 500 µm or less in nominal size, which may be suspended in air, may settle out of the atmosphere under their own weight, may burn or glow in air, and may form explosive mixtures with air at atmospheric pressure and normal temperatures.

Non-conductive dust: Combustible dust with electrical resistivity greater than $10^3 \Omega \cdot m$

Conductive dust: Combustible dust with electrical resistivity equal to or less than $10^3 \Omega \cdot m$

Combustible dust	Ignition temperature ⁽¹⁾ (°C)	Self-ignition temperature of dust layers ⁽¹⁾ (°C)
Starch	440	290
Aluminium	530	280
Cotton	560	350
Cereals	420	290
Magnesium	610	410
Soybean	500	245
Sulphur	280	280
Tabacco	450	300

- ⁽¹⁾ The maximum surface temperature must be identified and suitable for the specified type of dust present (equipment marked for zone 21). In order to prevent the ignition of dusty atmospheres, the maximum surface temperature needs to be limited. It must not exceed:
- 2/3 of the auto-ignition temperature of the specified **cloud of dust**,
 - the auto-ignition temperature of a 5 mm **layer of dust** minus 75°C.

TYPE EXAMINATION CERTIFICATES

SELECTION OF PRODUCTS

available at "www.asco.com"

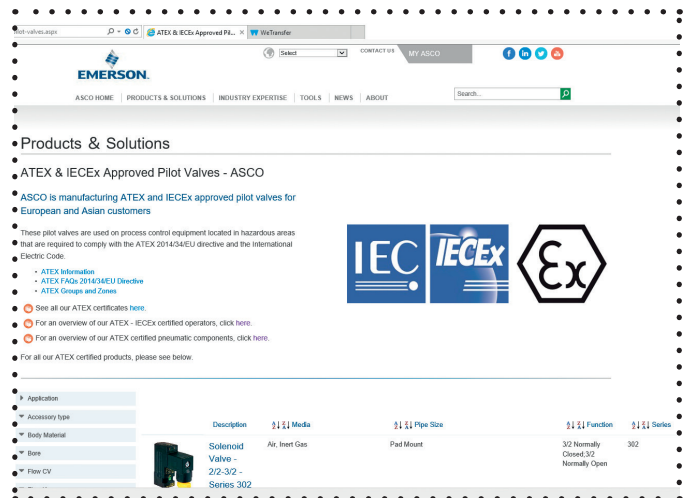
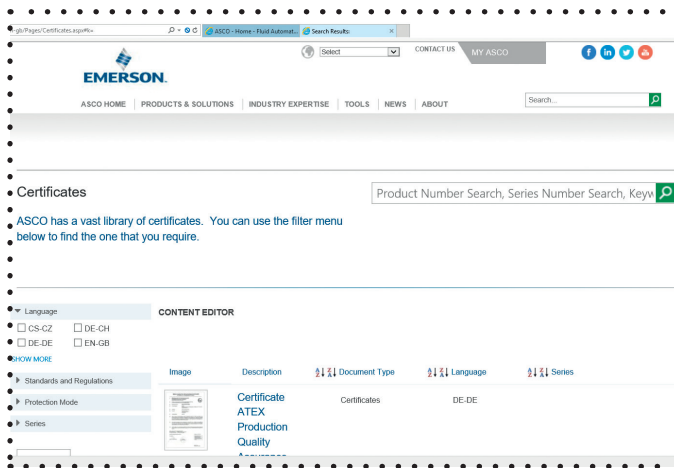

Certificates issued by the IECEx Certified Equipment Program are issued as "Electronic Certificates" and are live on the IECEx Website. This enables full public access for viewing and printing. Visit the IECEx "On-Line Certificate" System.

GENERAL

The accidental ignition of an atmosphere containing a large quantity of gas, vapour, mists and/or dust may cause an explosion. Specific measures have been taken on an **international level** in order to avoid any material damage or the loss of human lives.

These measures mainly apply to chemical and petrochemical industries where such hazardous atmospheres may be developed during the production, transformation, transport and storage of flammable products. They also cover installations where combustible dust is produced in the processing of pulverised and grain products (grinding and sieving).

SOME DEFINITIONS

What is a potentially explosive atmosphere?

3 elements must be combined to trigger an explosion:

- (A) **The oxygen in the surrounding air = always present**
- (B) **A flammable substance** (gas, vapours, mists or dusts)
- (C) **A source of ignition:** Electrical equipment / installation or any source of heat

A **spark** or a **flame** are not the only sources of ignition. An **increase of the surface temperature** of an electrical equipment may cause an explosion if it exceeds the ignition temperature of the surrounding gas or mixture of substances.

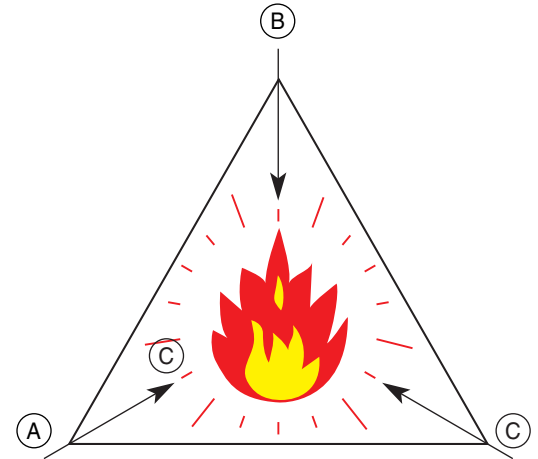

Removing just one of the 3 elements eliminates the entire risk

What is an explosive atmosphere?

This is an atmosphere which could become explosive (the danger is potentially present) due to the local or operational condition in an installation such as: leaks, rupture of pipeline, temperature variations, etc.

What is a gaseous or dusty explosive atmosphere?

This is a mixture with air, under atmospheric conditions, of flammable substances in the form of gases, vapours, mists or dusts in which, after ignition has occurred, combustion spreads to the entire unburned mixture (definition according to Directive 1999/92/EC).

What is the fundamental difference between a gaseous and a dusty atmosphere?

It's the density. The density of gases and vapours is approximately 1,000 times less than that of dusts. Gases are dispersed in the air due to convection and diffusion, thereby creating a homogeneous atmosphere. Since dusts are much heavier than air, they have the tendency to settle to the bottom more or less quickly.

What are the characteristic features of an explosive atmosphere caused by dust?

For a dusty atmosphere to become explosive, the following four conditions must be present:

- The dust must be flammable (particle size < 0.3 mm in general).
- The atmosphere must contain an oxidiser (generally oxygen, even in a very small quantity).
- The dusts must be in suspension. (The explosion will be caused by the extremely rapid rate of combustion of the dust in the oxygen in the air.)
- The dust concentration must be in the explosive range. (As a rule, the lower limit of explosion is around 50 g/m³.)

OBJECTIVES OF THE ATEX DIRECTIVE 2014/34/EU (“ATmosphères EXplosibles”)

To ensure free circulation of the products to which it is applicable throughout the territory of the European Union.

To remove barriers to trade via the **New Approach** by requiring a definition of **essential requirements regarding safety and health** by which a high level of protection will be ensured.

To cover by a single directive both mining and surface equipment.

To increase the scope as compared to national regulations by providing for the first time essential safety and health requirements for:

- **Non-electrical equipment** intended for use in potentially explosive atmospheres (EN 13463-1);
- Equipment intended for use in **dusty environments** as well as protective systems;
- Devices intended for use **outside explosive atmospheres** which are required for or contribute to the **safe functioning** of equipment or protective systems.

WHAT OBLIGATIONS DOES THE MANUFACTURER HAVE UNDER THIS DIRECTIVE?

The manufacturer has sole and ultimate responsibility for the conformity of his product to the applicable directives. He bears responsibility for:

- Ensuring the conformity of his products to the Directive (providing for certificates of conformity);
- Designing and constructing his products in accordance with the essential safety and health requirements;
- Following the procedures for the assessment of the conformity of the product.

EFFECTIVE DATE

Since 1 July 2003, all products placed on the market in the European Union have to conform to Directive 2014/34/EU.

After 30 June 2003, conformity to the ATEX directive is obligatory in order to enable free movement of products throughout the European Union. Only the New Approach remains valid. It takes into account:

- Hazardous areas;
- CE Marking;
- Dust atmospheres;
- The CENELEC standards EN 60079-0 for electrical equipment and followings (EN 60079-1/7/11/15/18/31);
- Standard EN 13463 for non-electrical equipment for potentially explosive atmospheres.

WHAT IS THE IECEx CERTIFICATION?

The IECEx International Certification Scheme is a voluntary certification system. It offers a certification of conformity with the IEC series of standards 60079. This certification facilitates the international trade of electrical equipment intended for use in explosive atmospheres and contributes to avoiding the multiplicity of national certifications while guaranteeing an adapted level of safety. The certification is issued by an organisation recognised by IECEx, an ExCB (Ex Certification Body).

- It provides direct access to the markets in Australia, New Zealand etc.
- It simplifies access to local certifications in Russia, China, USA etc.
- It reduces the time and costs for certification due to its international recognition.
- All certificates issued are available for download worldwide under «Online Certificates» at IECEx.com.

WHAT ARE EQUIPMENT PROTECTION LEVELS (EPLs)?

The degree of hazard is currently defined according to the probability of the occurrence of explosive atmospheres. Equipment Protection Levels (EPLs) are introduced to enable an alternative approach to selecting Ex equipment by taking into account the potential consequences of an explosion and other factors such as the toxicity of materials.

A risk assessment approach for the acceptance of explosion protected equipment has been introduced to clearly indicate the inherent ignition risk of the equipment, no matter what type of protection is used.

IEC / CENELEC COOPERATION

The main CENELEC EN 50014 standard (General Requirements) pertaining to electrical apparatus for potentially explosive atmospheres was originally published in 1977. It is derived from the IEC Publications 79.

From that date, these 2 organisations have constantly intensified their cooperation. The new series of standards 6 (60079-0, etc.) which replace the old standards are an example for the approximation between European and international standards.

WHAT ARE THESE 2 ORGANISATIONS?

IEC

The "International Electrotechnical Commission" (IEC), founded in 1906, has its head office in Geneva. The commission is currently composed of 55 national committees and 19 associate members. Its purpose is "fostering international cooperation in all issues relative to standardisation and in related subjects such as certification in the fields of electricity and electronics, and thus favouring international exchanges".

Since 1976, the IEC has been cooperating with the International Standard Organisation (ISO), among others.

CENELEC

The "European Committee for Electrotechnical Standardisation" (CENELEC) is a technical organisation located in Brussels. It is composed of the National Electrotechnical Committees from 33 European countries and 12 affiliated countries. The committee's major role is to harmonise national standards to produce a single European Standard ("EN"). In 1958, the standardisation process started, and in 1973, the name CENELEC was adopted with the expansion of the Common Market.

Within the CENELEC, the Technical Committee 31 is in charge of elaborating the standards for electrical apparatus intended for use in explosive atmospheres.

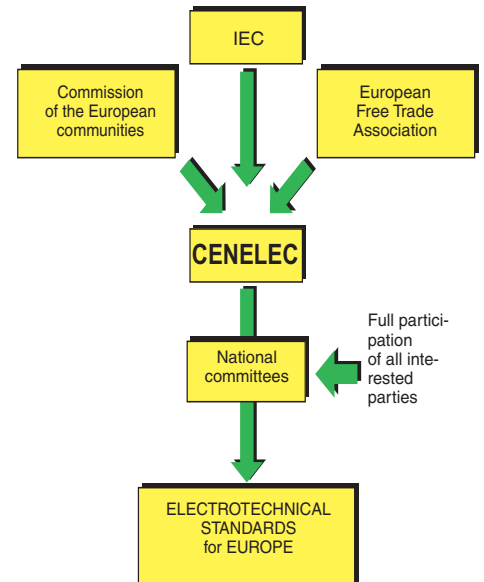

WHAT IS CEN?

CEN (European Committee for Standardisation) works in close partnership with CENELEC. CEN is a "European forum" for standardisation, with the exception of electro-technology, which fosters and organises relations between governments, governmental bodies, producers, users, consumers, trade unions etc. This is, in particular achieved by:

- harmonising published national standards and promoting ISO standards;
- elaborating new EN standards, developing procedures for the mutual recognition of test results etc. (Example: Standards EN 13463-1 to 8 for non-electrical apparatus).

LATEST DEVELOPMENTS IN THE STANDARDISATION OF EXPLOSIVE ATMOSPHERES

CENELEC and **CEN** have been entrusted with developing new directives as a support to harmonise the legislation of the Member States of the European Union.





Key dates to bear in mind:

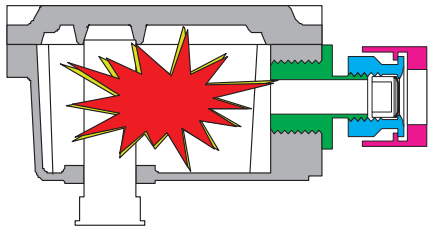

- 23 March 1994: Creation of Directive 94/9/EC (also called ATEX or ATEX 100A) in replacement of Directives 76/117/EEC, 79/196/EEC, 82/130/EEC. The directive is to form the basis of the current regulations relating to electrical and non-electrical equipment for explosive atmospheres.
- From 1996, transposition of the directive in the Member States of the European Union.
- **30 June 2003**, end of the transitory period: All products placed on the market throughout the European Union from 1 July 2003 must fulfil the safety and health requirements of Directive 94/9/EC.
- **2006-2009**: Gradual application of the new harmonised series of standards "6" (EN 60079-0...).
- **2007**: The 5th edition of IEC 60079-0:
- **2016**: The new Directive ATEX **2014/34/EU** applicable from April 20th, 2016 mainly concern:
 - the manner of notifying the bodies, which will have to be accredited beforehand;
 - the manner of implementing the relations between the Member States, in particular with respect to the market surveillance;
 - all the economic operators having a role in the ATEX product sales, will be more responsible. The responsibility of the ATEX product distributors and retailers is now clearly defined.

Due to the fact that we are in the European Union and not in the European Community some terms have changed:

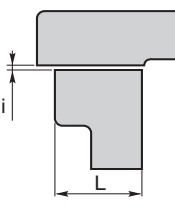
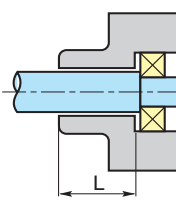
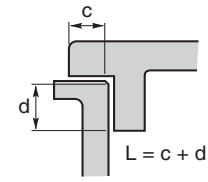
- The manufacturer will write an EU declaration of conformity
- The Notified Body will issue an EU type examination certificate

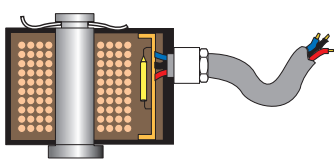
What are the types of protection derived from standard EN 60079-0 for ASCO ?

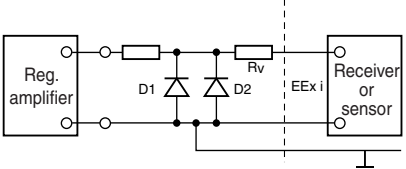
	Description	Characteristics
"d"	FLAMEPROOF ENCLOSURE	
	<p>The most currently used type of protection. Standard equipment is contained in a sturdy casing specifically designed for use in explosive atmospheres.</p>  <p>Features</p> <ul style="list-style-type: none"> - keeps an internal inflammation within a dimensionally stable enclosure; - prevents inflammation from penetrating the ambient atmosphere; - keeps the outside temperature of the enclosure below the ignition temperature of the ambient gas, vapours or dusts. 	<p>CONSTRUCTION</p> <p>Standard EN-IEC 60079-1 specifies the 2 following main characteristics for the construction of a "d" type enclosure to prevent an internal inflammation from igniting the ambient atmosphere:</p> <ul style="list-style-type: none"> - the length "L" (in mm) of the flameproof seal; - the maximum experimental safe gap (MESG) "i" (in mm). <div style="display: flex; justify-content: space-around;"> <div style="text-align: center;"> <p>flat seal ①</p>  </div> <div style="text-align: center;"> <p>cylindrical seal ②</p>  </div> <div style="text-align: center;"> <p>recessed seal ③</p>  </div> </div> <p>The dimensions given depend on the seal and volume of the enclosure and gas groups. Example: with a seal length $L = 12.5$ mm and an enclosure volume ≤ 100 cm³, the MESG "i" will be:</p> <p>I : 0,5 mm seals included ① / ② IIB : 0,2 mm seals included ① / ② IIA : 0,3 mm seals included ① / ② IIC : 0,15 mm seals included ③</p> <p>EN 60079-1: All non-threaded flamepaths have to be at 1.5 times the maximum gap (if the maximum gap stated for a flange joint is 0.1 mm, the product will be tested at 0.15 mm).</p> <p>OPERATING VOLTAGE, TEMPERATURE</p> <p>EN 60079-1:</p> <ul style="list-style-type: none"> - All equipment needs to be tested within the range of ± 10 % of its operating voltage; - If the ambient temperature is below -20°C, a test to determine the reference pressure is required unless a statement that the enclosure is unaffected by lower temperatures (i.e. it does not become more brittle) is furnished. <p>WIRING (by cable gland certified to ATEX)</p> <p>Standard EN 60079-1 specifies that the thread sizes (3/4 NPT, 1/2 NPT or M20) must be marked on the product or label or indicated in the installation and maintenance instructions. The cable glands must be certified in accordance with this new standard and must be appropriate for use within the ambient temperature range for which the product is certified.</p>
"m"	<p>Easy to install, the enclosure with this type of protection can be adapted to many models of electrical equipment.</p>  <p>Features</p> <ul style="list-style-type: none"> - encloses in a compound the electrical parts which are likely to ignite the ambient explosive atmosphere; - prevents ignition of the ambient explosive atmosphere. 	<p>CONSTRUCTION</p> <p>Standard EN 60079-18 defines that this type of protection must be used even in case of overvoltage or excessive current as a result of:</p> <ul style="list-style-type: none"> - an internal short-circuit; - the valve with blocked core in an open circuit. <p>A fuse is required with alternating current. The maximum surface temperature may not exceed the certified temperature class. The coil and electrical components must be enclosed in a compound (example: epoxy resin).</p> <p>EN 60079-18: ma for zone 0, mb for zone 1 et mc for zone 2.</p>  <p>WIRING</p> <p>By cable with 3 flying leads embedded in a compound. This airtight sealing prevents the ambient explosive atmosphere from penetrating the enclosure.</p>

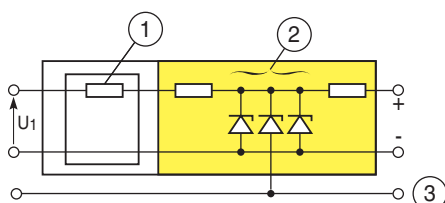
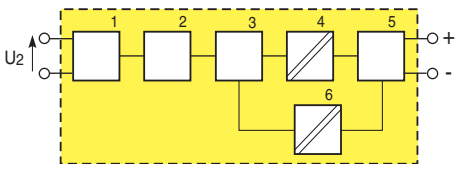
Description	Characteristics
<p style="text-align: center;">INTRINSIC SAFETY</p> <p>This type of protection takes into account the minimum energy necessary to ignite an explosive atmosphere. The whole circuit is designed in such a way that this energy must never be available, neither in normal operation nor in specific faulty operating conditions.</p> <p>How?</p> <ul style="list-style-type: none"> - By limiting peak current and no-load voltage; - By limiting thermal and electric energy storage. <p>Unlike the other types of protection which apply to single electrical components, this one applies to the whole circuit.</p> <p>Example of an intrinsically safe circuit:</p> <p>Non-hazardous zone Explosive zone</p>  <p style="text-align: center;">"i"</p> <p>What about the zones?</p> <p>Some components may present defects (reliability). Intrinsically safe components are classified into "ia", "ib" and «ic» groups depending on the number of defects and their location in hazardous area:</p> <p>"ia" (zones 0/20): 2 defects = intrinsically safe "ib" (zones 1/21-2/22): 1 defect = intrinsically safe</p> 	<p>WHAT IS EN 60079-11 BASED ON?</p> <p>EN 60079-11:</p> <ul style="list-style-type: none"> - Level of protection «ia» for zones 0/20, «ib» for zones 1/21 and «ic» for zones 2/22. - Reduced separation distances avec d'autres circuits - Operating temperature of elastomers according to EN 60079-0. <p>Explosion groups: identical to the type of protection "d", IIA-IIB-IIC.</p> <p>Energy storage: During circuit opening / closing, inductance or capacitance may partially release its energy in addition to the ignition power already available. A safety factor must then be applied.</p> <p>What about the electrical components? A distinction is made between apparatus rated intrinsically safe and their "associated components" in which the circuits may themselves be either intrinsically safe or not.</p> <p>DEVICES FOR ELECTRICAL SUPPLY</p> <p>Safety barrier It limits the available power in a circuit to specific values. The voltage is limited by Zener diodes, current by resistances (standard barriers) or by electronic systems (special barriers). It isolates the intrinsically safe circuit <i>without galvanic barriers</i>. To operate correctly, it must be connected to a reference potential = 0 (equipotential earth). This solution is preferable to interfaces (see below) which require a common earth.</p>  <p>① fuse ② Zener diodes ③ zero potential (equipotential earth or interconnected earth)</p> <p>Galvanic barrier (interface) Other intrinsically safe apparatus <i>with galvanic barriers</i> are used for various applications:</p> <ul style="list-style-type: none"> - Current-transmitters for 2-lead converters; - Transmitters; - Converters: temperature converters, electropneumatic I/P or P/I; - Amplifier relays; - Power packs with galvanic barriers. <p>The voltage U_2 at the entrance of an interface must be lower than the barrier voltage U_1 ($U_2 < U_1$).</p>  <p>① rectifier ② filter ③ logic control ④ galvanic protection (transformer) ⑤ output voltage adjustment ⑥ galvanic isolation (optocoupler)</p>

00015GB-2016/R02
Availability, design and specifications are subject to change without notice. All rights reserved.

All leaflets are available on: www.asco.com

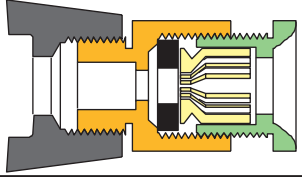
	Description	Characteristics
"e"	INCREASED SAFETY	
	<p><i>Prevents the occurrence of any accidental ignition source: arcs or sparks. Sparking components are excluded from this method of protection.</i></p> <p>How?</p> <ul style="list-style-type: none"> - Use of high quality insulation materials; - Min. IP54 ingress protection to reduce the probability of contamination by dirt and moisture ingress; - Special enclosure with connections which cannot become loose; - Taking account of specified temperature classes; - Conformity of cable entries and labelling. 	<p>WHAT IS EN 60079-7 BASED ON?</p> <p>Explosion group: I or II; Group II includes subdivisions IIA-IIB-IIC.</p> <p>Temperature class: The temperature which must be taken into account is that of the <i>hottest point of the equipment as a whole</i> and not that of the external temperature as is the case with flameproof enclosures. The temperature classification is identical to that of protection type "d".</p> <p>CONNECTION Securely fastened certified cable gland always supplied mounted on the product.</p> 

Detectors designed for use in explosive atmosphere zones 0-20, 1-21, 2-22, according to **ATEX directive 2014/34/EU**.

FUNCTIONAL DESCRIPTION

A permanent magnet (M) which is mounted on the piston of the air cylinder activates the reed switch of the non-contact magnetic position detector fastened on the outside of the non-magnetic cylinder barrel.

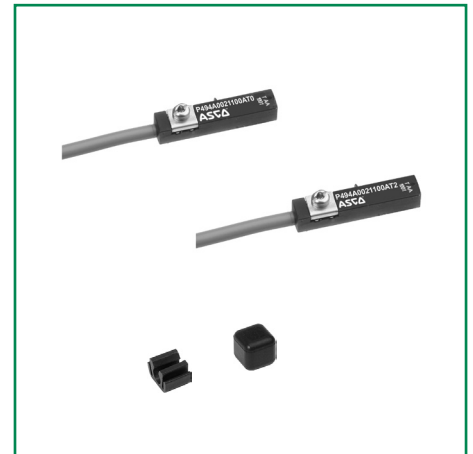
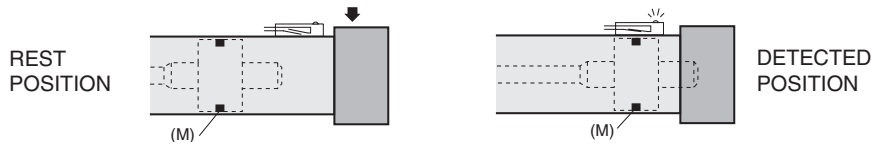

DETECTOR CHARACTERISTICS

ATEX APPROVAL	II 1G Ex ia IIC T4 Ga II 1D Ex ia IIIC T135°C Da	II 3G Ex nA IIC T4 Gc X II 3D Ex tc IIIC T125°C Dc X
MAX. SWITCHING POWER	-	5 W
SWITCHING VOLTAGE	-	5 to 30 VDC
MAX. SWITCHING CURRENT	-	100 mA
WIRING	-	PNP
REVERSE POLARITY PROTECTION	yes	yes
OVERLOAD PROTECTION	no	no
SHORT-CIRCUIT PROTECTION	no	no
VOLTAGE DROP (EN 60.947-5-2)	-	< 5 volt
CURRENT CONSUMPTION	≤ 1 mA* , ≥ 2 mA**	-
NOMINAL VOLTAGE	8,2 V	-
INTERNAL CAPACITANCE	10 nF	-
INTERNAL INDUCTANCE	400 μH	-
HYSTERESIS	1 mm	1 mm
BOUNCE TIME	0,6 ms	≤ 0,6 ms
BREAK TIME	0,1 ms	≤ 0,1 ms
SENSITIVITY	2,1 mTesla	2,1 mTesla
REPEATABILITY	< 0,2 mm	< 0,2 mm
WORKING TEMPERATURE	- 25°C , + 70°C	- 20°C , + 60°C
HOUSING	PA + GF overmoulding	PA + GF overmoulding
CABLE	PVC	PUR
DEGREE OF PROTECTION (IEC 60529)	IP67	IP65 / IP67
PROTECTION CLASS	class III	class III
SIGNAL INDICATION	yellow diode (LED) which lights up when the contact is established	
ELECTROMAGNETIC COMPATIBILITY (EMC)	EN 61000-4-2 ESD (electrostatic discharge): -CD/8kV AD EN 61000-4-3 radiated RF fields: 10 V/m (80 ... 2000MHz) EN 61000-4-4 electrical fast transients/burst: 2kV EN 61000-4-6 conducted RF fields: 10 V (0,15 ... 80 Mhz)	
CERTIFICATION	EN 55011: class B CE, ATEX 1G/D, ATEX 3G/D	

* without signal ** with signal

CHOICE OF DETECTOR

	Use with barrier Max. values: U=15 V, I=50 mA, P=120 mW	5 to 30 Volt DC
Connection	PVC lead, 5 m long 2 wires 0,14 mm ² stripped ends 	PUR lead, 5 m long 2 wires 0,14 mm ² stripped ends
Protective cover supplied with detector	-	
Weight (g)	50	
Compatible cylinders:	STANDARD CATALOGUE NUMBER detector detector supplied with cable holding clip and adjustment position stop	
449 - 453 ⁽¹⁾	P494A0021100AT0	P494A0021100AT2
441 - 435 - 438 - 450 - 454 ⁽²⁾		

⁽¹⁾ Detector designed for direct fitting to "T" cylinder grooves

⁽²⁾ [Fastening kit required](#)

ACCESSORIES AND OTHER ELECTRICAL CHARACTERISTICS: see following page

All leaflets are available on: www.asco.com

Cable 5 m long, 2 wires 0,14 mm ² stripped ends		
zones	classification	type approval certificate no.
0-20/1-21/2-22	II 1G Ex ia IIC T4 Ga ⁽¹⁾ II 1D Ex ia IIIC T135°C Da	DEKRA BVS 10 ATEX 023
2-22	II 3G Ex nA IIC T4 Gc X II 3D Ex tc IIIC T125°C Dc X	-

(1) Compatible barriers and interfaces

Manufacturer	Version	Module type
MTL	1 way	MTL501 1B, Zener MTL7741,
	2 way	Zener MTL7743, MTL5018, MTL5018ac
PEPPERL & FUCHS	1 way	KFD2-SR2-Ex1.W, KFA6-SR2-Ex1.W KFA6-SR2-Ex1.W
	2 way	KFD2-SR2-Ex2.W, KFA6-SR2-Ex2.W, KFA6-SR2-Ex2.W

MAXIMUM ELECTRICAL CHARACTERISTICS AND PROTECTION OF MAGNETIC DETECTOR (REED SWITCH)

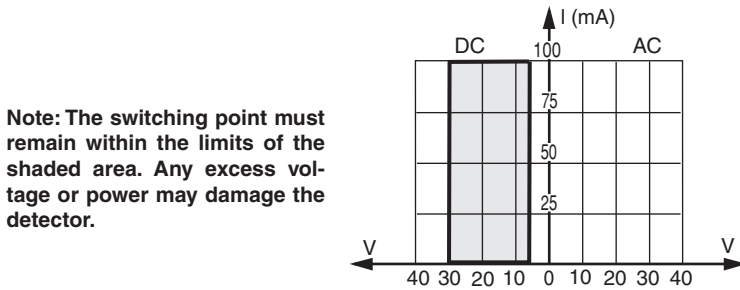

Note: The switching point must remain within the limits of the shaded area. Any excess voltage or power may damage the detector.

INDUCTIVE LOAD		100 Ω 4 W	100 Ω 4 W
		0,1 μF 250 V	0,1 μF 250 V
RESISTIVE LOAD		Protection not necessary	

PARTICULAR APPLICATIONS (valid for all models)

- Detectors used for direct control of incandescent lamps: The capacity specified on the lamp is based on its resistance when hot. When switched on, the resistance of the cold lamp is very low. Therefore, the current rises quickly and may exceed the reed switch rating. Allowance should therefore be made for the real power of the cold lamp.
- With leads longer than 10 m, a 1000 Ω resistor must be fitted in series with the detector to reduce the capacitive effect caused by the wiring.

R = 4 W resistor. Standard CCTU resistor code RP 59,
C = Paper, polycarbonate or metallised mylar capacitor.
The user is responsible for supplying and assembling the components.

REED SWITCH CONNECTION

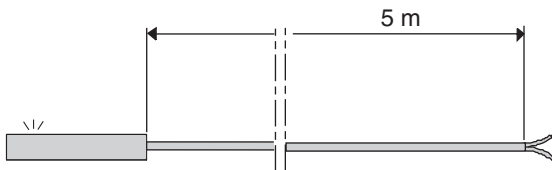

Lead outlet Ø 3 mm, stripped ends
2 wires 0,14 mm² - brown wire = +
bluw wire = -

ACCESSORIES

description	catalogue number
detector position adjustment memory unit 	P4994406160N001

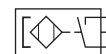

Detectors designed for use in explosive atmosphere zones 0-20, 1-21, 2-22, according to **ATEX directive 2014/34/EU**.

PRINCIPLE

Static non-contact proximity switch on air cylinders equipped with built-in permanent magnets.

FUNCTIONAL DESCRIPTION

When the permanent magnet which is mounted on the piston approaches the detector the magnetic field it generates causes the semiconductors' resistors to change. This current variation increases the resistance and a switching signal is generated.



DETECTOR CHARACTERISTICS

ATEX APPROVAL	II 1GEx ia IIC T4 Ga II 1D Ex ia IIIC T135°C Da	II 3G Ex nA IIC T4 Gc X II 3D Ex tc IIIC T125°C Dc X
MAX. SWITCHING POWER	-	3 W
SWITCHING VOLTAGE	-	10 to 30 VDC
MAX. SWITCHING CURRENT	-	100 mA
WIRING	-	PNP
REVERSE POLARITY PROTECTION	yes	yes
OVERLOAD PROTECTION	no	yes
SHORT-CIRCUIT PROTECTION	no	yes
VOLTAGE DROP (EN 60.947-5-2)	-	< 2,5 volt
CURRENT CONSUMPTION	≤ 1 mA* , ≥ 2 mA**	< 10 mA
NOMINAL VOLTAGE	8,2 V	-
INTERNAL CAPACITANCE	140 nF	-
INTERNAL INDUCTANCE	400 μH	-
HYSTERESIS	1 mm	1 mm
SWITCHING FREQUENCY	-	> 6000 Hz
SENSITIVITY	2 mTesla	2 mTesla
RESPONSE TIME	-	30 ms
REPEATABILITY	< 0,2 mm	< 0,2 mm
WORKING TEMPERATURE	- 25°C , + 70°C	- 20°C , + 60°C
HOUSING	PA + GF overmoulding	PA + GF overmoulding
CABLE	PVC	PVC
DEGREE OF PROTECTION (IEC 60529)	IP67	IP65 / IP67
PROTECTION CLASS	class III	class III
SIGNAL INDICATION	yellow diode (LED) which lights up when the contact is established	
ELECTROMAGNETIC COMPATIBILITY (EMC)	EN 61000-4-2 ESD (electrostatic discharge): -CD/8kV AD EN 61000-4-3 radiated RF fields: 10 V/m (80 ... 2000MHz) EN 61000-4-4 electrical fast transients/burst: 2kV EN 61000-4-6 conducted RF fields: 10 V (0,15 ... 80 Mhz)	
CERTIFICATION	EN 55011: class B CE, ATEX 1G/D, ATEX 3G/D	

* without signal ** with signal

CHOICE OF DETECTOR

	Use with barrier Max. values: U=15 V, I=50 mA, P=120 mW	10 to 30 Volt DC
Connection	PVC lead, 5 m long 2 wires 0,14 mm ² stripped ends 	PVC lead, 5 m long 3 wires 0,14 mm ² stripped ends
Protective cover supplied with detector	-	PNP
Weight (g)	50	
Compatible cylinders:	STANDARD CATALOGUE NUMBER detector detector supplied with cable holding clip and adjustment position stop	
449 - 453 ⁽¹⁾	P494A0023100AT0	P494A0022100AT2
441 - 435 - 438 - 450 - 454 ⁽²⁾		

(1) Detector designed for direct fitting to "T" cylinder grooves

(2) [Fastening kit required](#)

ACCESSORIES AND OTHER ELECTRICAL CHARACTERISTICS: see following page

All leaflets are available on: www.asco.com

Cable 5 m long, 2 wires 0,14 mm ² stripped ends		
zones	classification	type approval certificate no.
0-20/1-21/2-22	II 1G Ex ia IIC T4 Ga ⁽¹⁾ II 1D Ex ia IIIC T135°C Da	DEKRA BVS 10 ATEX 023
2-22	II 3G Ex nA IIC T4 Gc X II 3D Ex tc IIIC T125°C Dc X	-

(1) Compatible barriers and interfaces

Manufacturer	Version	Module type
MTL	1 way	MTL501 1B, Zener MTL7741,
	2 way	Zener MTL7743, MTL5018, MTL5018ac
PEPPERL & FUCHS	1 way	KFD2-SR2-Ex1.W, KFA6-SR2-Ex1.W KFA6-SR2-Ex1.W
	2 way	KFD2-SR2-Ex2.W, KFA6-SR2-Ex2.W, KFA6-SR2-Ex2.W

ELECTRICAL PROTECTION

- Output protected against short-circuit as long as the output current is restricted to 0.1 A.
- Improper wire connection may prevent the detector from operating or even destroy it.
- It is recommended to install a protection diode (mounted in parallel) on an inductive load in spite of the internal protection.

Connection

2 wires (for barrier protection)

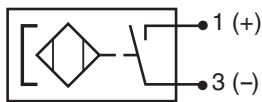

3 wires (PNP)

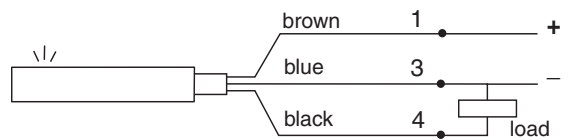
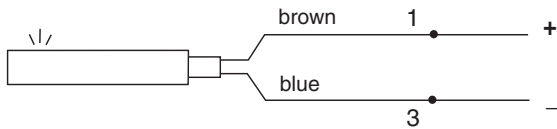
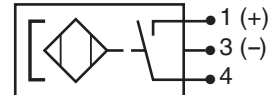

CONNECTION OF MAGNETO-RESISTIVE DETECTORS:

2 wires (for barrier protection)

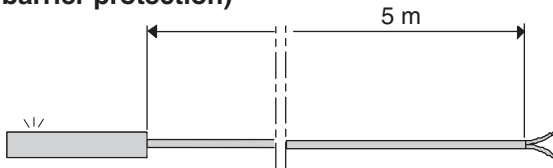

PVC lead outlet Ø 3 mm, stripped ends
2 wires 0,14 mm² - **Brown wire** : +
Blue wire : -

3 wires (PNP)

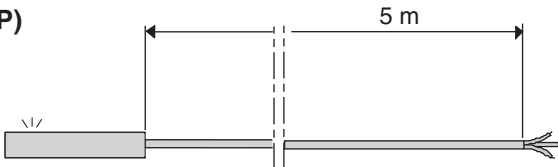

PVC lead outlet Ø 3 mm, stripped ends
3 wires 0,14 mm² - **Brown wire** : +
Blue wire : -
Black wire : load

ACCESSORIES

description	catalogue number
detector position adjustment memory unit	 P4994406160N001

FOR "T" GROOVE CYLINDERS

series	Ø (mm)	code fastening kit
441	32 ... 100	(1)
449	32 ... 100	(1)
453	32 ... 100	(1)
454	32 ... 100	no groove

(1) Fastening mini-kit (special nut + screw) supplied **with** detectors

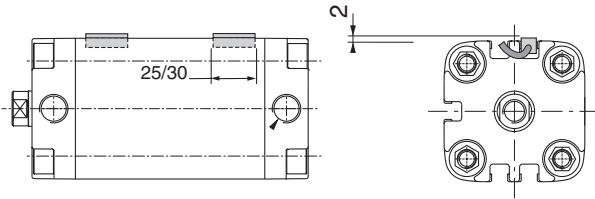

NOTE:

Series 441 cylinders Ø 32-100 mm : 6 "T" grooves

Series 449 cylinders Ø 20-25 mm : 4 "T" grooves
Ø 32-100 mm : 5 "T" grooves

Series 453 cylinders Ø 32-100 mm : 5 "T" grooves

Series 454 cylinders Special adaptor for magnetic detector (code: **P494A0029100A00**)



In order to control **the max. end** of cylinder stroke, the detectors must be mounted in the following direction:

Series 441-449-453-454 cylinders:

Ø32-40: cable oriented towards the middle of the cylinder
Ø50-100: any position

FOR TIE RODS CYLINDERS

series	Ø (mm)	code fastening kit
		lead outlet version
450	32-40	P494A3129200A00
	50-63-80	P494A5129200A00
	100	P494A8129200A00
	125-160-200	P494AP129200A00



Ø cylinder	32	40	50	63	80	100	125	160	200
D	30	33	38	44	50	69	77	89	104
E	26	30	35	39	49	61	69	87	101

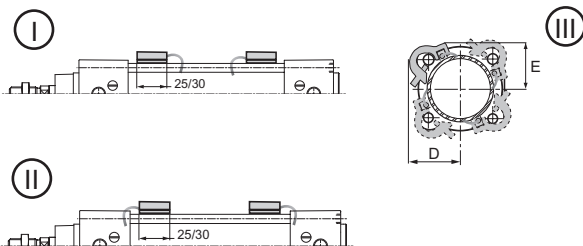

- I It is possible to fasten the detector with its electric outlet to the centre of the cylinder (in order to be able to control the **max. end** of travel of the cylinder)
- II In order to fasten the detector with its electric outlet to the rear, rotate **the unit** detector + collar by 180°
- III The detectors can be mounted on any one of the 4 **tie rods**.

00570GB-2017/R01
Availability, design and specifications are subject to change without notice. All rights reserved.

All leaflets are available on: www.asco.com



FOR ROUND CYLINDERS

series	Ø (mm)	code fastening kit	
		plastic	stainless steel (AISI 303 + 304)
435 438	8-10	-	P494AG129600A00
	12	P494AJ129300A00	P494AK129600A00
	16	P494AK129300A00	P494AK129600A00
	20	P494AL129300A00	P494AL129600A00
	25	P494AM129300A00	P494AL129600A00
	32	P494A3129300A00	P494A3129600A00
	40	P494A4129300A00	P494A4129600A00
	50	-	P494A5129600A00
	63	-	P494A6129600A00

Ø 12 to 40 mm

Ø 8 to 80 mm

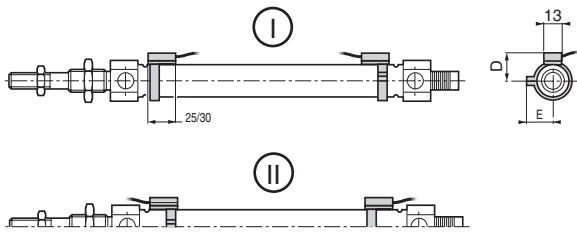

It is possible to mount magnetic detectors for **intermediate** position indication : mounting by collar

Ø 8-20 : any position.

Ø 25-80 : cable oriented towards the cylinder ends

Ø cylinder	8	10	12	16	20	25	32	40	50	63
D	14,5	15,5	15	16,5	19	21,5	26,5	31	38	45
E	13,5	14,5	16,5	19	20,5	23	29,5	31,5	36,5	43,5

- ⓘ On all diameters, it is possible to mount the detector with its electrical outlet facing towards the cylinder barrel (in order to be able to control the **max. end** of travel of the cylinder).
- Ⓜ In order to fasten the detector on cylinder diameters 25 to 63 with its electrical outlet facing towards the cylinder ends, rotate the detector + collar **unit** by 180°.