

ASCO™ Solenoid Valves

single/dual solenoid (mono/bistable function) - pilot operated
aluminium body - 1/4" and 1/2" tapped

3/2 NC
SERIES
551 - 553

Features

- The monostable spool valves in conformity with IEC 61508 Standard (2010 route 2_H version) have TÜV (551 series) and EXIDA (551-553 series) certified with integrity levels: SIL 2 for HFT = 0 / SIL 3 for HFT = 1
- The spool valves 3/2 NC have threaded port connections
- All the exhaust ports of the spool valve are connectable, providing better environmental protection. Particularly recommended for sensitive areas, such as clean rooms, and applications in the pharmaceutical and food processing sectors
- The valves offer environmental protection against the ingress of liquids, dusts or other foreign matter (environmentally-protected construction)
- Can be externally piloted (external air pilot supply) to convert valve to zero minimum operation by flipping a gasket
- The solenoid valves satisfy all relevant EU directives

General

Differential pressure 2 - 10,4 bar [1 bar = 100 kPa]
Flow (Qv at 6 bar) 1/4 = 860 l/min (ANR)
1/2 = 3800 l/min

fluids (*)	temperature range (TS)	seal materials (*)
air, inert gas, filtered	-25°C to +60°C	NBR (nitrile) + PUR (polyurethane)

Materials in contact with fluid

(*) Ensure that the compatibility of the fluids in contact with the materials is verified

Body	Aluminium, black anodised
End cover (spring return)	Glass-filled PA
Spool valve internal parts	Zamak, stainless steel, POM, aluminium
Pilot internal parts	Refer to specific solenoid catalogue pages
Pilot end covers	Aluminium
Core tube	Stainless steel
Core and plugnut	Stainless steel
Core spring	Stainless steel
Seals	NBR
Top disc	PA
Disc holder	CA
Cartridge (low power)	Welded, stainless steel or aluminium
Seat	Brass
Seat insert	CA
Shading coil	Copper
Rider rings (low power)	PTFE (NF/WSNF solenoids only)

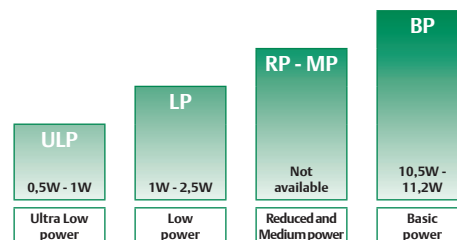
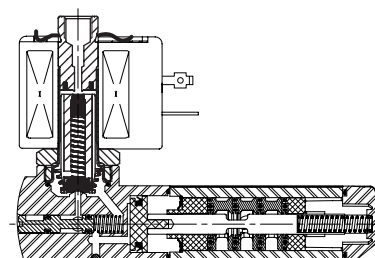
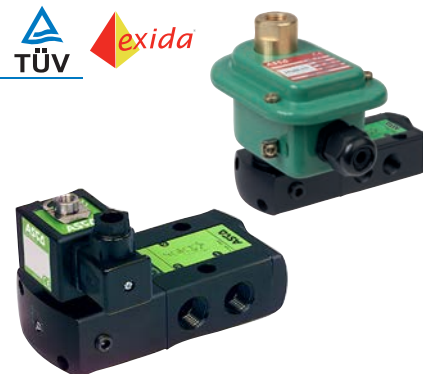
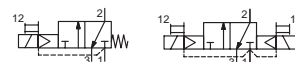

POWER LEVELS - cold electrical holding values (watt)

Specifications

pipe size	orifice size	flow coefficient Kv		operating pressure differential (bar)			power level	prefix optional solenoids							basic catalogue number					
								min. ⁽¹⁾	max. (PS)		NEMA	ATEX / IECEx				IP65				
									air (*)			7 & 9	Ex db	Ex eb mb			Ex mb	Ex ia		
(*)	(mm)	(m ³ /h)	(l/min)		~	=	~/=	EF ⁽²⁾	LPKF	NF	EM	PV	LI	WSLI	SC					
Solenoid air pilot operated - spring return (monostable)																				
1/4	6	0,75	12,5	0 / 2	10	10	BP	-	-	●	●	●	-	-	-	●	❖551B405 ⁽³⁾			
							BP	●	-	-	-	-	-	-	-	-	●	❖551H405 ⁽³⁾		
							LP	-	●	●	●	○	-	-	-	-	-	●	❖551B305 ⁽³⁾	
							LP	○	-	-	-	-	-	-	-	-	-	-	●	❖551G305 ⁽³⁾
							ULP	-	○	-	-	-	-	○	○	-	-	-	-	●
1/2	13	3,15	52,5	0 / 2	10	10	ULP	○	-	-	-	-	-	-	-	-	●	❖551H305 ⁽³⁾		
							BP	-	-	●	●	●	-	-	-	-	●	❖553A405 ⁽³⁾		
							BP	●	-	-	-	-	-	-	-	-	-	-	●	❖553H405 ⁽³⁾
							LP	-	●	●	●	○	-	-	-	-	●	❖553A305 ⁽³⁾		
							LP	○	-	-	-	-	-	-	-	-	-	-	●	❖553G305 ⁽³⁾
1/2	13	3,15	52,5	0 / 2	10	10	ULP	-	○	-	-	-	-	○	○	-	❖553A305 ⁽³⁾			
							ULP	○	-	-	-	-	-	-	-	-	-	-	●	❖553H305 ⁽³⁾

❖ Select 8 for NPT ANSI 1.20.3 or select G for ISO G (228/1) ● Available feature ○ Available feature in DC only. - Not available

⁽¹⁾ Zero minimum is only achieved if external pressure is applied.

⁽²⁾ UL CSA

⁽³⁾ Certified IEC 61508 Functional Safety data, use suffix "SL".

Specifications

pipe size	orifice size	flow coefficient Kv		operating pressure differential (bar)			power level	prefix optional solenoids							basic catalogue number		
								max. (PS)		NEMA 7 & 9	ATEX / IECEx			IP65			
				min. (1)	air (*)	EF (2)		LPKF	NF		EM	PV	LI			WSLI	SC
(*)	(mm)	(m³/h)	(l/min)	~	=	~/=	EF (2)	LPKF	NF	EM	PV	LI	WSLI	SC			
Solenoid air pilot operated and return (bistable)																	
1/4	6	0,75	12,5	0/2	10	10	BP	-	-	●	●	●	-	-	●	❖551B406	
							BP	●	-	-	-	-	-	-	-	-	❖551H406
							LP	-	●	●	●	○	-	-	●	❖551B306	
							LP	○	-	-	-	-	-	-	-	-	❖551G306
							ULP	-	○	-	-	-	-	○	○	-	❖551B306
							ULP	○	-	-	-	-	-	-	-	-	❖551H306
1/2	13	3,15	52,5	0/2	10	10	BP	-	-	●	●	●	-	-	●	❖553A406	
							BP	●	-	-	-	-	-	-	-	-	❖553H406
							LP	-	●	●	●	○	-	-	●	❖553A306	
							LP	○	-	-	-	-	-	-	-	-	❖553G306
							ULP	-	○	-	-	-	-	○	○	-	❖553A306
							ULP	○	-	-	-	-	-	-	-	-	❖553H306

❖ Select 8 for NPT ANSI 1.20.3 or select G for ISO G (228/1) ● Available feature ○ Available feature in DC only. - Not available
(1) Zero minimum is only achieved if external pressure is applied. (2) UL CSA

Prefix table

prefix							description	power level			
1	2	3	4	5	6	7		ULP	LP	MP	BP
E	F						Explosionproof - NEMA 7, 9 - Zinc plated steel conduit (18" continuous leads)	○	○	-	●
E	F	H	T				EF (18" continuous leads) + high temperature	○	○	-	●
E	F	H	T	L			EF + high temperature + 72" continuous leads	○	○	-	●
E	F	L					EF + 72" continuous leads	○	○	-	●
J	B	E	F				EF + junction box (conduit in 1/2" NPT)	○	○	-	●
J	B	E	F	M	F		EF + junction box (conduit in 1/2" NPT) + surge suppression coils	○	○	-	●
J	C	E	F				EF + junction box (conduit in 3/4" NPT)	○	○	-	●
J	C	E	F	H	T		EF + junction box (conduit in 3/4" NPT) + high temperature	○	○	-	●
E	M						Waterproof IP66/67 - Metal enclosure (EN/IEC 60079-7,-18 and -31)*	-	●	-	●
		E	T				Threaded conduit/hole (M20 x 1,5)	-	●	-	●
L	P	K	F				Flameproof - Aluminium (EN/IEC 60079-1, 60079-31)*	○	●	-	-
N	F						Flameproof - Aluminium (EN/IEC 60079-1, 60079-31)*	-	●	-	●
P	V						Encapsulated epoxy moulded (EN/IEC 60079-18)*	-	○	-	●
S	C						Solenoid with spade plug connector (EN/IEC 60730)	-	●	-	●
W	P						Waterproof IP67 - Metal enclosure	-	●	-	●
L	I						I.S. with Aluminium IP66/IP67 enclosure (EN/IEC 60079-11+31)*	○	-	-	-
W	S						Waterproof IP67 - 316 SS enclosure	-	●	-	●
W	S	L	P	K	F		Flameproof 316L SS (EN/IEC 60079-1, 60079-31)*	○	●	-	-
W	S	E	M				Waterproof IP66/67 - 316 SS enclosure (EN/IEC 60079-0+7+18+31)*	-	●	-	●
W	S			L	I		I.S. with 316L SS IP66/IP67 enclosure (EN/IEC 60079-11+31)*	○	-	-	-
W	S	N	F				Flameproof 316L SS (EN/IEC 60079-1, 60079-31)*	-	●	-	●
		T					Threaded conduit (1/2" NPT)	-	●	-	●
				H	T		Class H - High temperature, +80°C ambient temp.	-	●	-	●
						X	Other special constructions	-	●	-	●

Suffix table

suffix							description	power level			
1	2	3	4	5	6	7		ULP	LP	MP	BP
	S	L		M	O		Push type manual operator	○	○/●	-	●
							Certified IEC 61508 Functional Safety data (2)	○	○/●	-	●

Options & Accessories

series	pipe size	exhaust protector (stainless steel)		
		G	NPT	(M)
551-553	1/8	34600418 (3)	34600482 (3)	-
551	1/4	34600419 (3)	34600483 (3)	-
553	1/2	34600479 (3)	34600479 (3)	-
551	M5	-	-	34600484 (3)

- Available feature
- Available feature in DC only
- Not available
- * ATEX/IECEx valves using these solenoids are approved according to EN ISO 80079-36 (2016) and EN ISO 80079-37 (2016) [non electrical]
- (2) Not to use with MO suffix
- (3) Provided with "SL" suffix

Ordering examples valves:

SC	G	551	B	405		230V / 50 Hz
SC	G	551	B	405	SL	230V / 50 Hz
SC	G	551	B	406	MO	230V / 50 Hz
SCHT	8	551	B	406	MO	230V / 50 Hz
LPKF	G	551	B	305	MO	24V / DC
LI	G	553	A	305		24V / DC
EM	8	553	A	406	MO	230V / 50 Hz
EF	G	551	H	405	MO	240V / 60 Hz

prefix
pipe thread
basic number
voltage
suffix

Explanation of temperature ranges of solenoid valves

Valve temperature range	The valve temperature range (TS) is determined by the selected seal material, the temperature range for proper operation of the valve and sometimes by the fluid (e.g. steam)
Operator ambient temperature range	The operator ambient temperature range is determined by the selected power level and the safety code
Total temperature range	The temperature range of the complete solenoid valve is determined by the limitations of both temperature ranges above

Electrical characteristics

Coil insulation class	F
Electrical safety	IEC 335
Standard voltages	DC (=) 24V - 48V AC (-) 24V - 48V - 115V - 230V ⁽¹⁾ /50Hz; other voltages and 60Hz are available on request

prefix option	power ratings				operator ambient temperature range (TS) (C°) ⁽²⁾	safety code	electrical enclosure protection (EN 60529)	replacement coil / kit		type ⁽³⁾	
	inrush		holding					hot/cold =	~		=
	(VA)	(VA)	(W)	(W)							
Basic power (BP)											
SC	55	23	10,5	9/11,2	-40 to +75	EN 60730	IP65, moulded	400425-117	400425-142	01	
WP/WS	55	23	10,5	9/11,2	-40 to +75	EN 60730	IP67, steel /SS	400405-117	400405-142	03	
NF/WSNF	55	23	10,5	-	-60 to +25/40/60	II2G Ex db IIC Gb T6/T5/T4, II2D Ex tb IIIC Db	IP66/67, alu./SS	400405-117	-	02	
NF/WSNF	-	-	-	9/11,2	-60 to +40/60/75	II2G Ex db IIC Gb T6/T5/T4, II2D Ex tb IIIC Db	IP66/67, alu./SS	-	400405-142	02	
EM/WSEM	55	23	10,5	9/11,2	-40 to +40	II2G Ex eb mb IIC Gb T3, II2D Ex tb IIIC Db	IP66/67, steel /SS	400909-117	400913-142	03	
PV	55	23	10,5	9/11,2	-40 to +65	II2G Ex mb IIC Gb T3(-)/T4(=), II2D Ex mb IIIC Db	IP67, moulded	- ⁽⁴⁾	- ⁽⁴⁾	04	
EF	55	23	10,5	9/11,2	-40 to +52/40	NEMA type 7 and 9	NEMA 4X	-	-	05	
EFHT	55	23	10,5	9/11,2	-40 to +52/40	NEMA type 7 and 9	NEMA 4X	-	-	05	
JBEF	55	23	10,5	9/11,2	-40 to +52/40	NEMA type 7 and 9	NEMA 4X	-	-	11	
JBEFHT	55	23	10,5	9/11,2	-40 to +52/40	NEMA type 7 and 9	NEMA 4X	-	-	11	
Low Power (LP)											
SC	1,5	1,5	1,5	1,7/1,7	-40 to +60	EN 60730	IP65, moulded	400925-097	400925-042	06	
WP/WS	1,5	1,5	1,5	1,7/1,7	-40 to +60	EN 60730	IP67, steel /SS	400926-097	400926-042	08	
LPKF/WSLPKF	2,4	2,4	2,4	-	-40 to +40/65/80	II2G Ex db IIB+H2 Gb T6/T5/T4, II2D Ex tb IIIC Db	IP66/67, alu./SS	- ⁽⁴⁾	- ⁽⁴⁾	12	
LPKF/WSLPKF	-	-	-	2,1 ⁽⁵⁾	-40 to +40/80	II2G Ex db IIB+H2 Gb T6/T4, II2D Ex tb IIIC Db	IP66/67, alu./SS	- ⁽⁴⁾	- ⁽⁴⁾	12	
NF/WSNF	1,85	1,85	1,85	1,5/1,8	-60 to +75/80	II2G Ex db IIC Gb T6/T5, II2D Ex tb IIIC Db	IP66/67, alu./SS	- ⁽⁴⁾ (1)	- ⁽⁴⁾	07	
EM/WSEM	1,5	1,5	1,5	1,7/1,7	-40 to +40/55	II2G Ex eb mb IIC Gb T6/T5, II2D Ex tb IIIC Db	IP66/67, steel /SS	- ⁽⁴⁾	- ⁽⁴⁾	08	
PV	-	-	-	1,7/1,7	-40 to +65	II2G Ex mb IIC Gb T6, II2D Ex mb IIIC Db	IP67, moulded	-	- ⁽⁴⁾	09	
EF	-	-	-	1,8/1,8	-40 to +60	NEMA type 7 and 9	NEMA 4X	-	-	10	
EFHT	-	-	-	1,8/1,8	-40 to +60	NEMA type 7 and 9	NEMA 4X	-	-	10	
JBEF	-	-	-	1,8/1,8	-40 to +60	NEMA type 7 and 9	NEMA 4X	-	-	11	
JBEFHT	-	-	-	1,8/1,8	-40 to +60	NEMA type 7 and 9	NEMA 4X	-	-	11	
Ultra Low Power (ULP)											
LPKF/WSLPKF	-	-	-	0,5/0,5 ⁽⁵⁾	-40 to +60	II2G Ex db IIB+H2 Gb T6, II2D Ex tb IIIC Db	IP66/67, alu./SS	-	- ⁽⁴⁾	12	
EF	-	-	-	0,55/0,7	-40 to +52/40	NEMA type 7 and 9	NEMA 4X	-	-	10	
EFHT	-	-	-	0,55/0,7	-40 to +52/40	NEMA type 7 and 9	NEMA 4X	-	-	10	
JBEF	-	-	-	0,55/0,7	-40 to +52/40	NEMA type 7 and 9	NEMA 4X	-	-	11	
JBEFHT	-	-	-	0,55/0,7	-40 to +52/40	NEMA type 7 and 9	NEMA 4X	-	-	11	
LI ⁽⁶⁾ (7)	-	-	-	0,5/0,5	-40 to +60	II1G Ex ia IIC T6 Ga, II2D Ex tb IIIC Db ⁽⁷⁾	IP66/67, alu.	-	- ⁽⁴⁾	13	
WSLI ⁽⁶⁾ (7)	-	-	-	0,5/0,5	-40 to +60	II1G Ex ia IIC T6 Ga, II2D Ex tb IIIC Db ⁽⁷⁾	IP66/67, SS	-	- ⁽⁴⁾	13	

prefix option	safety parameters				
	U _i = (DC)	I _i	P _i	L _i	C _i
	(V)	(mA)	(W)	(H)	(μF)
Ultra Low Power (ULP)					
LI/WSLI	32	500	1,5	0	0

- (1) (WS)NF: Low Power, 230 V AC does not exist. Maximum voltage in AC is 115 V
(2) Temperature range can be limited by sealings
(3) Refer to the dimensional drawings on pages: 5 to 8
(4) Multiple coil kits are available under ATEX/IECEx, contact us
(5) LPKF/WSLPKF: 24 V DC (0,5 W)
(6) LI/WSLI: Check the electrical characteristics in the corresponding catalogue pages
(7) LI/WSLI: Ultra Low Power, 24 V DC only (LI: For use in zone 0 locations, see the installation conditions given in the I&M instructions)
- Not available

Electrical connections

prefix	connection
SC	Spade plug connector with cable gland EN175301-803A (ISO 4400) for cables with an outer diameter from 6 to 10 mm
WP, WS, EM, WSEM	M20 plastics cable gland for cables with an outer diameter from 7 to 12 mm.
NF, WSNF, LPKF, WSLPKF	1/2" NPT threaded cable entry. Enclosures are supplied without cable gland
PV	Moulded-in cable, standard length 2 m
LI, WSLI	1/2" NPT threaded cable entry. Enclosures are supplied without cable gland
EF	1/2" NPT conduits
JBEF	EF + Junction box

Additional options

- Valves configured for external pilot air supply, TPL 20547
- Other pipe threads are available on request
- Ex mb (prefix "PV") solenoid can be supplied with various cable lengths

Installation

- Multi language installation/maintenance instructions are included with each valve
- The solenoid valves can be mounted in any position without affecting operation
- Do not connect the pressure supply to the exhaust port 3. The "environmentally-protected" construction is not adapted for a "distributing" function or use in NO function. Contact us for functions available in specific versions
- IEC 61508 Functional Safety (suffix SL). Check temperature range of valve body and solenoid for suitability. For probability of failure, contact us
- It is necessary to connect pipes or fittings to the exhaust ports to protect the internal parts of the spool valve and its pneumatic operator if used outside or in harsh environments (dusts, liquids etc.)
- Threaded pipe connection identifier is 8 = NPT (ANSI 1.20.3); G = G (ISO 228/1)
- Ex db Prefix "NF/WSNF" enclosure is provided with a 1/2" NPT threaded entry hole, M20 x 1,5 (prefix "ET") is optional. These are supplied without cable gland

Dimensions (mm), Weight (kg) 

551 Series

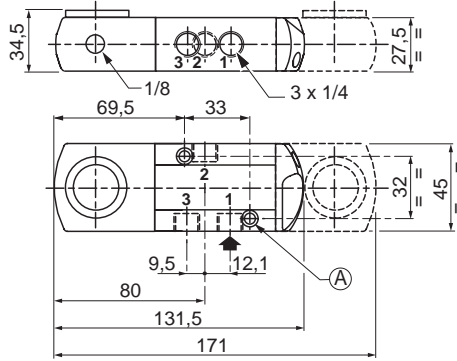

(A) 2 mounting holes: 5,3 mm dia.;
Spotfacing: 9 mm dia., depth 5 mm

553 Series

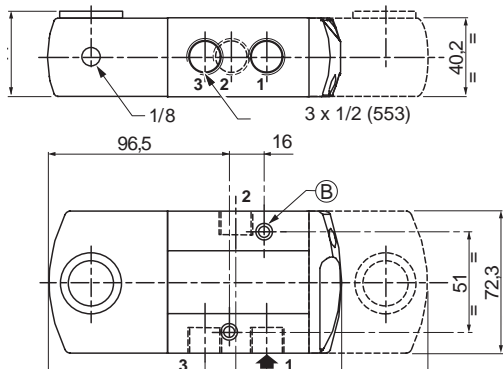

(B) 2 mounting holes: 6,5 mm dia.;
Spotfacing: 11 mm dia., depth 6 mm



TYPE 01:
Epoxy moulded
SC: IEC 335 / ISO 4400

551B405 / B406 / B405MO / B406MO
553A405 / A406 / A405MO / A406MO



TYPE 02:
Aluminium, epoxy coated / AISI 316L SS
NF / WSNF: EN/IEC 60079-1, 60079-31

551B405 / B406 / B405MO / B406MO
553A405 / A406 / A405MO / A406MO

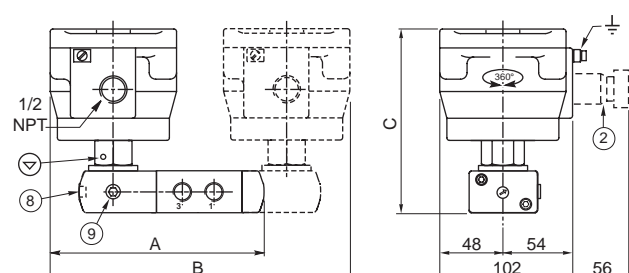
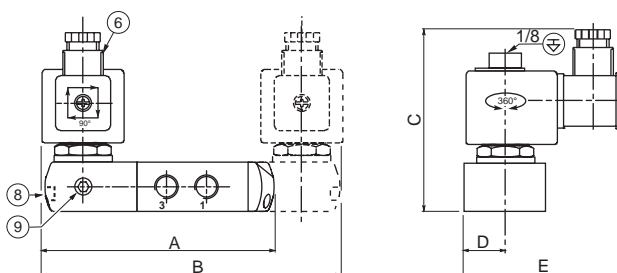

80050CB-2019/R02

**3/2 NC
SERIES
551 - 553**

Dimensions (mm), Weight (kg) 



TYPE 03:
Metal, epoxy coated / AISI 316L SS
WP / WS: IEC 335
EM / WSEM: EN/IEC 60079-7+18+31

551B405 / B406 / B405MO / B406MO
553A405 / A406 / A405MO / A406MO

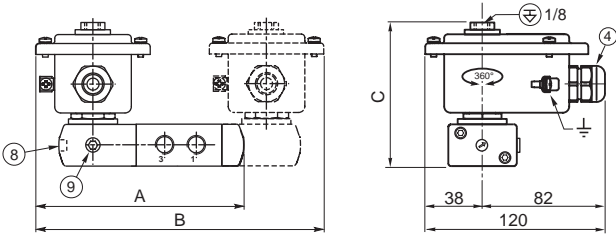

TYPE 04:
Epoxy encapsulated
PV: EN/IEC 60079-18

551B405 / B406 / B405MO / B406MO
552A405 / A406 / A405MO / A406MO

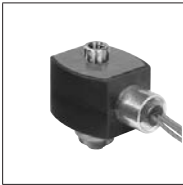
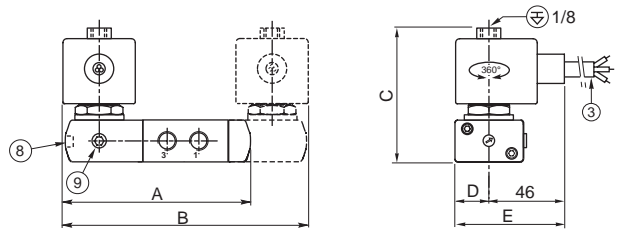

TYPE 05:
Epoxy encapsulated
EF: NEMA type 7, 9 / ICS-6 ANSI

553H405 / H406 / H405MO / H406MO

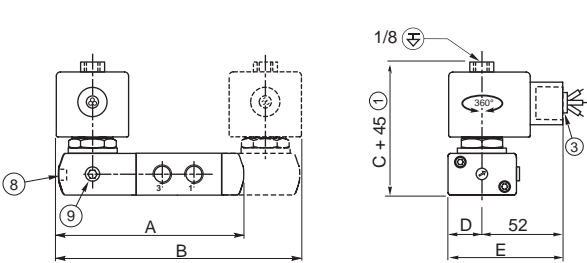

TYPE 06:
Epoxy moulded
SC: IEC 335 / ISO 4400

551B305 / B306 / B305MO / B306MO
553A305 / A306 / A305MO / A306MO

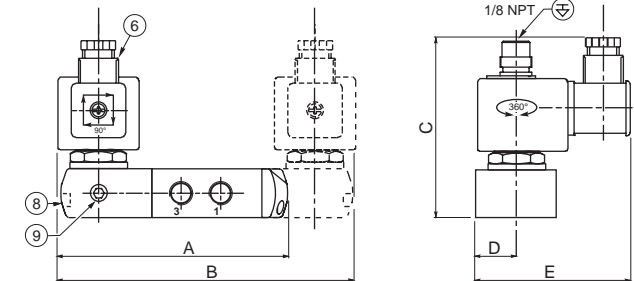

TYPE 07:
Aluminium, epoxy coated / AISI 316L SS
NF / WSNF: EN/IEC 60079-1, 60079-31

551B305 / B306 / B305MO / B306MO
553A305 / A306 / A305MO / A306MO

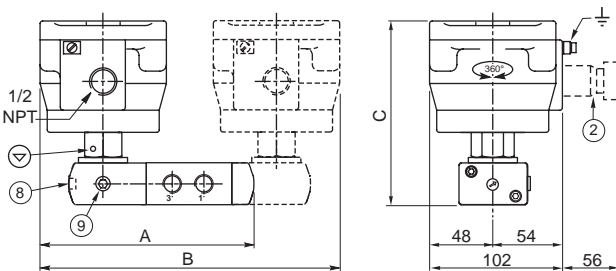

TYPE 08:
Metal, epoxy coated / AISI 316L SS
WP / WS: IEC 335
EM / WSEM: EN/IEC 60079-7+18+31

551B305 / B306 / B305MO / B306MO
553A305 / A306 / A305MO / A306MO

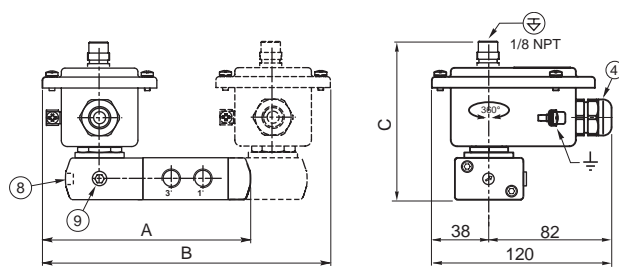

80050CB-2019/R02

DIMENSIONS (mm), WEIGHT (kg) 



TYPE 09:
Epoxy encapsulated
PV: EN/IEC 60079-18

551B305 / B306 / B305MO / B306MO
553A305 / A306 / A305MO / A306MO

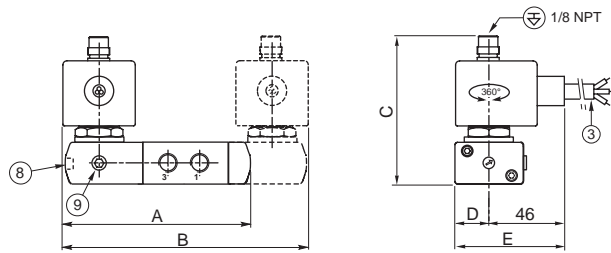

TYPE 10:
Epoxy encapsulated
EF: NEMA type 7, 9 / ICS-6 ANSI

551G305 / H305 / G306 / H306 / G305MO / H305MO / G306MO / H306MO
553G305 / H305 / G306 / H306 / G305MO / H305MO / G306MO / H306MO

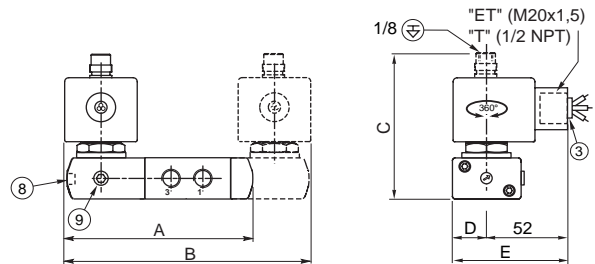

TYPE 11:
Epoxy encapsulated
JBEF: NEMA type 7, 9

551G305 / H305 / G306 / H306 / G305MO / H305MO / G306MO / H306MO
553G305 / H305 / G306 / H306 / G305MO / H305MO / G306MO / H306MO

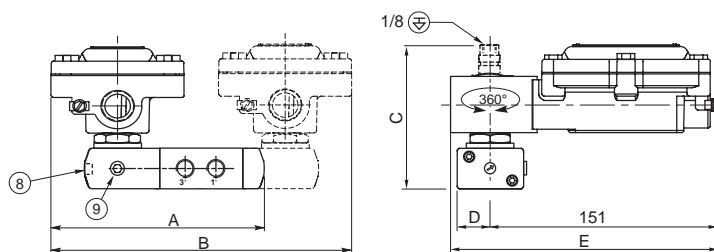

TYPE 12:
Aluminium, cataphoresis black painting / AISI 316L SS
LPKF/WSPKF: EN/IEC 60079-1, 60079-31

551B305 / B306 / B305MO / B306MO
553A305 / A306 / A305MO / A306MO

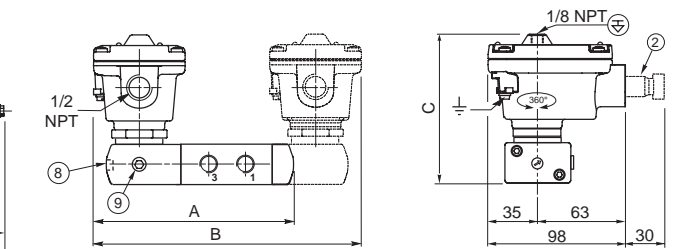

TYPE 13:
Aluminium, cataphoresis black painting / AISI 316L SS
LI / WSLI: EN/IEC 60079-11, 60079-31

551B305 / B306 / B305MO / B306MO
553A305 / A306 / A305MO / A306MO

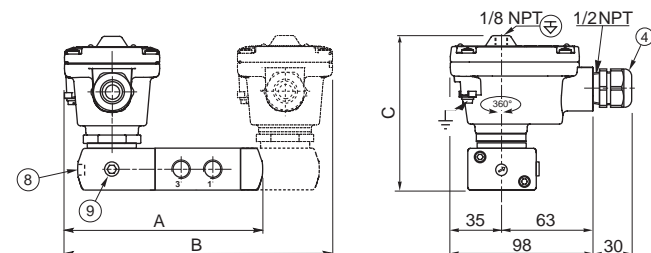

Dimensions (mm), Weight (kg) 

- ② Ex d certified cable gland (on request)
- ③ Three-core cable, length 2 m
- ④ Cable gland for unarmoured cable with 7 to 12 mm dia. sheath
- ⑥ Connector rotatable by 90° increments, cable Ø 6 - 10 mm
- ⑧ Manual operator location, suffix MO
- ⑨ External pilot air supply, 1/8 pipe size
- ⊕ Connectable pilot exhaust port
- ⊖ Non-connectable pilot exhaust port

type	prefix/option	power level	A		B		C		D		E		weight ⁽¹⁾			
			monostable		bistable								monostable		bistable	
			551	553	551	553	551	553	551	553	551	553	551	553	551	553
01	SC	BP	132	152,5	170	198	102,7	112,2	22,5	36,15	86,5	100,2	0,76	1,35	1,34	1,91
02	NF / WSNF	BP	158	197,3	224	287,6	141,8	151,3	-	-	-	-	1,85	2,39	3,51	4,05
03	WP/WS	BP	148	169,2	204	231,3	103	112,5	-	-	-	-	0,84	1,36	1,49	1,93
03	(WS)EM	BP	148	169,2	204	231,3	103	112,5	-	-	-	-	0,84	1,36	1,49	1,93
04	PV	BP	132	152,5	172	198	88	97,5	22,5	36,15	67,5	81,2	0,82	1,36	1,45	1,92
05	EF	BP	132,5	156	173	205	85,5	95	22,5	36,15	74,5	88,2	0,64	1,36	1,29	1,93
06	SC	LP	132,5	153,5	173	200	101,5	111	22,5	36,15	87,5	101,2	0,97	1,56	1,55	2,16
07	NF / WSNF	LP	158	197,3	224	287,5	141,8	151,3	-	-	-	-	1,85	2,39	3,51	4,05
08	WP/WS/(WS)EM	LP	148	169,2	204	231,3	102,2	111,7	-	-	-	-	1,05	1,57	1,70	2,14
09	PV	LP	132	152,5	172	198	100,5	110	22,5	36,15	67,5	81,2	1,03	1,57	1,67	2,13
10	EF	LP	132,5	156	173	205	100,5	110	22,5	36,15	74,5	88,2	0,85	1,57	1,50	2,14
11	JBEF	BP / LP / ULP	153,5	174,5	215	236	100,5	110	22,5	36,15	176	187,5	1,32	1,84	2,44	2,88
12	LPKF	LP / ULP	141	164,5	192	222	113	122,5	-	-	-	-	0,90	1,76	1,62	2,21
12	WSLPKF	LP / ULP	141	164,5	192	222	113	122,5	-	-	-	-	1,51	2,77	2,82	3,28
13	LI	ULP	141	164,5	192	222	113	122,5	-	-	-	-	0,91	1,77	1,63	2,22
13	WSLI	ULP	141	164,5	192	222	113	122,5	-	-	-	-	1,52	2,38	2,83	3,42

⁽¹⁾ Incl. coil(s) and connector(s).

Accessories

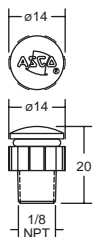

pilot exhaust protector
part number
276405-001

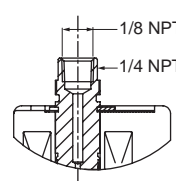

pilot top exhaust low power
(ASCO solenoid interface)

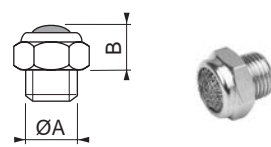

ØA	M5	1/8	1/4	3/8	1/2
B	4,5	10	11	11	14

exhaust protector
(stainless steel)